



MERCEDES

A large, light gray, faded version of the ABR logo, consisting of three slanted parallel lines followed by the letters 'ABR'.

MERCEDES

Nº ABR	MOTOR	DESCRIÇÃO		PÁGINA
66116081	OM314	JOGO DE JUNTAS COMPLETO	SEM RETENTORES E COM JUNTA DE CABEÇOTE 98,5 MM	44
76116081	OM314	JOGO DE JUNTAS COMPLETO	COM RETENTORES E COM JUNTA DE CABEÇOTE 98,5 MM	44
76126081	OM314	JOGO DE JUNTAS COMPLETO	COM RETENTORES E COM JUNTA DE CABEÇOTE 100,0 MM	44
76136081	OM314	JOGO DE JUNTAS SUPERIOR	COM RETENTORES E COM JUNTA DE CABEÇOTE 98,5 MM	44
76121681	OM364	JOGO DE JUNTAS COMPLETO	COM RETENTORES E COM JUNTA DE CABEÇOTE 98,5 MM	46
76111681	OM364	JOGO DE JUNTAS COMPLETO	COM RETENTORES E COM JUNTA DE CABEÇOTE 100,0 MM	46
76121671	OM364A	JOGO DE JUNTAS COMPLETO	COM RETENTORES E COM JUNTA DE CABEÇOTE 98,5 MM	46
76111671	OM364A	JOGO DE JUNTAS COMPLETO	COM RETENTORES E COM JUNTA DE CABEÇOTE 100,0 MM	46
76131671	OM364/364A	JOGO DE JUNTAS SUPERIOR	COM RETENTORES E COM JUNTA DE CABEÇOTE 98,5 MM	46
76131681	OM364/364A	JOGO DE JUNTAS SUPERIOR	COM RETENTORES E COM JUNTA DE CABEÇOTE 100,0 MM	46
76141721	OM352	JOGO DE JUNTAS COMPLETO	COM RETENTORES E COM JUNTA DE CABEÇOTE 98,5 MM	50
76121721	OM352	JOGO DE JUNTAS COMPLETO	COM RETENTORES E COM JUNTA DE CABEÇOTE 100,0 MM	50
76141031	OM352A/LA	JOGO DE JUNTAS COMPLETO	COM RETENTORES E COM JUNTA DE CABEÇOTE 98,5 MM	50
76121031	OM352A/LA	JOGO DE JUNTAS COMPLETO	COM RETENTORES E COM JUNTA DE CABEÇOTE 100,0 MM	50
76131721	OM352A/LA	JOGO DE JUNTAS SUPERIOR	COM RETENTORES E COM JUNTA DE CABEÇOTE 98,5 MM	50
76131031	OM352A/LA	JOGO DE JUNTAS SUPERIOR	COM RETENTORES E COM JUNTA DE CABEÇOTE 100,0 MM	50
66113121	OM355/5 CILINDROS	JOGO DE JUNTAS COMPLETO	SEM RETENTORES	54
76113121	OM355/5 CILINDROS	JOGO DE JUNTAS COMPLETO	COM RETENTORES	54
76133121	OM355/5 CILINDROS	JOGO DE JUNTAS SUPERIOR	COM RETENTORES	54
66112501	OM355/6 CILINDROS	JOGO DE JUNTAS COMPLETO	SEM RETENTORES	58
76112501	OM355/6 CILINDROS	JOGO DE JUNTAS COMPLETO	COM RETENTORES	58
76132501	OM355/6 CILINDROS	JOGO DE JUNTAS SUPERIOR	COM RETENTORES	58
76121691	OM366	JOGO DE JUNTAS COMPLETO	COM RETENTORES E COM JUNTA DE CABEÇOTE 98,5 MM	62
76111691	OM366	JOGO DE JUNTAS COMPLETO	COM RETENTORES E COM JUNTA DE CABEÇOTE 100,0 MM	62
76121701	OM366A	JOGO DE JUNTAS COMPLETO	COM RETENTORES E COM JUNTA DE CABEÇOTE 98,5 MM	62
76141701	OM366A	JOGO DE JUNTAS COMPLETO	COM RETENTORES E COM JUNTA DE CABEÇOTE 100,0 MM	62
76112791	OM366LA	JOGO DE JUNTAS COMPLETO	COM RETENTORES E COM JUNTA DE CABEÇOTE 100,0 MM	62
76131701	OM366A/366LA	JOGO DE JUNTAS SUPERIOR	COM RETENTORES E COM JUNTA DE CABEÇOTE 98,5 MM	62
76131691	OM366A/366LA	JOGO DE JUNTAS SUPERIOR	COM RETENTORES E COM JUNTA DE CABEÇOTE 100,0 MM	62
76196115	OM447A/447LA	JOGO DE JUNTAS COMPLETO	COM RETENTORES	66
66196115	OM447A/447LA	JOGO DE JUNTAS COMPLETO	SEM RETENTORES	66
76196125	OM449A/449LA	JOGO DE JUNTAS COMPLETO	COM RETENTORES	66
66196125	OM449A/449LA	JOGO DE JUNTAS COMPLETO	SEM RETENTORES	66
76136125	OM447/OM449	JOGO DE JUNTAS MONOCILÍNDRICO	COM RETENTORES	66
66136125	OM447/OM449	JOGO DE JUNTAS MONOCILÍNDRICO	SEM RETENTORES	66
66114611	OM457LA	JOGO DE JUNTAS COMPLETO	SEM RETENTORES E SEM ANÉIS DE CAMISA (ATÉ MOTOR 32558)	68
76114611	OM457LA	JOGO DE JUNTAS COMPLETO	COM RETENTORES E SEM ANÉIS DE CAMISA (ATÉ MOTOR 32558)	68
76114619	OM457LA	JOGO DE JUNTAS COMPLETO	COM RETENTORES E COM ANÉIS DE CAMISA (ATÉ MOTOR 32558)	68
66134611	OM457LA	JOGO DE JUNTAS MONOCILÍNDRICO	SEM RETENTORES E SEM ANÉIS DE CAMISA (ATÉ MOTOR 32558)	68
76134611	OM457LA	JOGO DE JUNTAS MONOCILÍNDRICO	COM RETENTORES E SEM ANÉIS DE CAMISA (ATÉ MOTOR 32558)	68
76134619	OM457LA	JOGO DE JUNTAS MONOCILÍNDRICO	COM RETENTORES E COM ANÉIS DE CAMISA (ATÉ MOTOR 32558)	68
66114631	OM457LA	JOGO DE JUNTAS COMPLETO	SEM RETENTORES E SEM ANÉIS DE CAMISA (APÓS MOTOR 32559)	70
76114631	OM457LA	JOGO DE JUNTAS COMPLETO	COM RETENTORES E SEM ANÉIS DE CAMISA (APÓS MOTOR 32559)	70
76114639	OM457LA	JOGO DE JUNTAS COMPLETO	COM RETENTORES E COM ANÉIS DE CAMISA (APÓS MOTOR 32559)	70
76134599	OM457LA	JOGO DE JUNTAS MONOCILÍNDRICO	COM RETENTORES E COM ANÉIS DE CAMISA (APÓS MOTOR 32559)	70
76134609	OM457LA	JOGO DE JUNTAS MONOCILÍNDRICO	COM RETENTORES E COM ANÉIS DE CAMISA (APÓS MOTOR 32559)	70
76114651	OM611	JOGO DE JUNTAS COMPLETO	COM RETENTORES	72
76134651	OM611	JOGO DE JUNTAS SUPERIOR	COM RETENTORES	72
76119041	OM904	JOGO DE JUNTAS COMPLETO	COM RETENTORES PARA TAMPA DE VÁLVULAS DE PLÁSTICO	74
66119041	OM904	JOGO DE JUNTAS COMPLETO	SEM RETENTORES PARA TAMPA DE VÁLVULAS DE PLÁSTICO	74
76119241	OM924	JOGO DE JUNTAS COMPLETO	COM RETENTORES PARA TAMPA DE VÁLVULAS DE PLÁSTICO	74
66119241	OM924	JOGO DE JUNTAS COMPLETO	SEM RETENTORES PARA TAMPA DE VÁLVULAS DE PLÁSTICO	74
76139041	OM904	JOGO DE JUNTAS SUPERIOR	COM RETENTORES PARA TAMPA DE VÁLVULAS DE PLÁSTICO	74
76139241	OM904	JOGO DE JUNTAS SUPERIOR	COM RETENTORES PARA TAMPA DE VÁLVULAS DE PLÁSTICO	74
76119061	OM906	JOGO DE JUNTAS COMPLETO	COM RETENTORES PARA TAMPA DE VÁLVULAS DE PLÁSTICO	76
66119061	OM906	JOGO DE JUNTAS COMPLETO	SEM RETENTORES PARA TAMPA DE VÁLVULAS DE PLÁSTICO	76
76119261	OM926	JOGO DE JUNTAS COMPLETO	COM RETENTORES PARA TAMPA DE VÁLVULAS DE PLÁSTICO	76
66119291	OM926	JOGO DE JUNTAS COMPLETO	SEM RETENTORES PARA TAMPA DE VÁLVULAS DE PLÁSTICO	76
76136061	OM906	JOGO DE JUNTAS SUPERIOR	COM RETENTORES PARA TAMPA DE VÁLVULAS DE PLÁSTICO	76
76139261	OM926	JOGO DE JUNTAS SUPERIOR	COM RETENTORES PARA TAMPA DE VÁLVULAS DE PLÁSTICO	76
76114682	OM612	JOGO DE JUNTAS COMPLETO	COM RETENTORES E COM FLANGE TRASEIRA	78
76134682	OM612	JOGO DE JUNTAS SUPERIOR	COM RETENTORES	78
76112702	OM651	JOGO DE JUNTAS COMPLETO	COM RETENTORES	80
76132702	OM651	JOGO DE JUNTAS SUPERIOR	COM RETENTORES	80
76114735	OM501(MOTOR 012091 ATÉ 084423)	JOGO DE JUNTAS COMPLETO	COM RETENTORES SEM ANEL DE CAMISA	82
76114745	OM501(MOTOR 084424 ATÉ 155295)	JOGO DE JUNTAS COMPLETO	COM RETENTORES SEM ANEL DE CAMISA	82
76114715	OM501(MOTOR 155296 ATÉ 377748)	JOGO DE JUNTAS COMPLETO	COM RETENTORES SEM ANEL DE CAMISA	82
76114725	OM501(APÓS MOTOR 377749)	JOGO DE JUNTAS COMPLETO	COM RETENTORES SEM ANEL DE CAMISA	82

MERCEDES

Nº ABR	MOTOR	DESCRIÇÃO		PÁGINA
76134735	OM501/502(MOTOR 012091 ATÉ 084423)	JOGO DE JUNTAS SUPERIOR	COM RETENTORES	82
76134745	OM501/502 (MOTOR 084424 ATÉ 155295)	JOGO DE JUNTAS SUPERIOR	COM RETENTORES	82
76134715	OM501/502 (MOTOR 155296 ATÉ 377748)	JOGO DE JUNTAS SUPERIOR	COM RETENTORES	82
76134725	OM501/502 (APÓS MOTOR 377749)	JOGO DE JUNTAS SUPERIOR	COM RETENTORES	82
76134730	OM501 TODOS OS MOTORES	JOGO DE JUNTAS INFERIOR	COM RETENTORES SEM JUNTA DE CÁRTER	82
76134720	OM501 (ATÉ MOTOR 012090)	JOGO DE JUNTAS INFERIOR	COM RETENTORES COM JUNTA DE CÁRTER SOFT	82
76134710	OM501 (APÓS MOTOR 012091)	JOGO DE JUNTAS INFERIOR	COM RETENTORES COM JUNTA DE CÁRTER BORRACHA	82
76114755	OM502 (MOTOR 012091 ATÉ 084423)	JOGO DE JUNTAS COMPLETO	COM RETENTORES SEM ANEL DE CAMISA	84
76114765	OM502 (MOTOR 084424 ATÉ 155295)	JOGO DE JUNTAS COMPLETO	COM RETENTORES SEM ANEL DE CAMISA	84
76114775	OM502 (MOTOR 155296 ATÉ 377748)	JOGO DE JUNTAS COMPLETO	COM RETENTORES SEM ANEL DE CAMISA	84
76114785	OM502 (APÓS MOTOR 377749)	JOGO DE JUNTAS COMPLETO	COM RETENTORES SEM ANEL DE CAMISA	84
76134735	OM501/502 (MOTOR 012091 ATÉ 084423)	JOGO DE JUNTAS SUPERIOR	COM RETENTORES	84
76134745	OM501/502 (MOTOR 084424 ATÉ 155295)	JOGO DE JUNTAS SUPERIOR	COM RETENTORES	84
76134715	OM501/502 (MOTOR 155296 ATÉ 377748)	JOGO DE JUNTAS SUPERIOR	COM RETENTORES	84
76134725	OM501/502 (APÓS MOTOR 377749)	JOGO DE JUNTAS SUPERIOR	COM RETENTORES	84
76134760	OM502 (TODOS)	JOGO DE JUNTAS INFERIOR	COM RETENTORES SEM JUNTA DE CÁRTER	84
76134750	OM502 (ATÉ MOTOR 012090)	JOGO DE JUNTAS INFERIOR	COM RETENTORES COM JUNTA DE CÁRTER SOFT	84
76134740	OM502 (APÓS MOTOR 012091)	JOGO DE JUNTAS INFERIOR	COM RETENTORES COM JUNTA DE CÁRTER BORRACHA	84

MERCEDES OM 314 4 CILINDROS 3.8L

Nº JOGO		DESCRIÇÃO			
66116081		JOGO DE JUNTAS COMPLETO OM 314 COM JUNTA DE CABEÇOTE 98,5MM SEM RETENTORES	1		
76116081	3435860090	JOGO DE JUNTAS COMPLETO OM 314 COM JUNTA DE CABEÇOTE 98,5MM COM RETENTORES	2		
76126081	3435860090	JOGO DE JUNTAS COMPLETO OM 314 COM JUNTA DE CABEÇOTE 100,0MM COM RETENTORES	3		
76136081		JOGO DE JUNTAS SUPERIOR OM 314 COM JUNTA DE CABEÇOTE 98,5MM COM RETENTORES	4		
Nº ABR	Nº ORIGINAL	DESCRIÇÃO			
56108701	3140160220	JUNTA DO CABEÇOTE - OM314 / 364 / 364A Ø 98,5 MM	1	1	1
56131803	3640160320	JUNTA DO CABEÇOTE - OM314 / 364 / 364A Ø 100,0 MM		1	
56111616	3140160121	JUNTA DA TAMPA DAS VÁLVULAS	1	1	1
56112616	3141420180	JUNTA DO COLETOR DE ESCAPAMENTO	1	1	1
86115759	3145860201	KIT DE JUNTAS DO CÂRTER (4 PEÇAS)		1	1
56110359	3520150320	JUNTA DA TAMPA DA DISTRIBUIÇÃO		1	1
56134894	3430150080	JUNTA TRASEIRA DA DISTRIBUIÇÃO		1	1
50051167	0009979641	GAXETA (CONJUNTO COM 2 PEÇAS)		1	1
RE01810S		RETENTOR DIANTEIRO DO VIRABREQUIM		1	1
56100298	3211310279	JUNTA DO CABEÇOTE DO COMPRESSOR		1	1
56100590	3522030680	JUNTA DO CAVALETE DE ÁGUA	2	2	2
56100890	71511022006	JUNTA DA TUBULAÇÃO DE ÁGUA		1	1
56102690	0000911280	JUNTA DA FLANGE DA BOMBA ALIMENTADORA		1	1
56106450	3520180180	JUNTA DA TAMPA DA BOMBA DE ÓLEO		1	1
56106595	3120760279	JUNTA DA BOMBA INJETORA		1	1
56106794	3211310079	JUNTA DA CAMISA DO COMPRESSOR		1	1
56109090	3271840280	JUNTA DA FLANGE DO FILTRO DE ÓLEO		1	1
56109398	3522010980	JUNTA DO SUPORTE DA BOMBA DE ÁGUA		1	1
56109498	3522010480	JUNTA DA CARÇA DA BOMBA DE ÁGUA		1	1
56109598	3522030080	JUNTA DA CARÇA DO TERMOSTATO	2	2	2
56109698	3522030480	JUNTA DO TERMOSTATO DA BOMBA DE ÁGUA	1	1	1
56109798	3522030780	JUNTA DO TERMOSTATO AO CABEÇOTE	1	1	1
56110116	071511060004	JUNTA DO TUBO DE SAÍDA DO ESCAPAMENTO		1	1
56110450	3120150680	JUNTA DA INSPEÇÃO DA DISTRIBUIÇÃO		1	1
56111590	3420150080	JUNTA DO RADIADOR DE ÓLEO		1	1
56111850	3140150622	JUNTA DA TAMPA LATERAL DAS VÁLVULAS		1	1
56112398	3140160280	JUNTA DO TUBO DE SUÇÇÃO	1	1	1
56114190	3141840379	JUNTA DA FLANGE DO FILTRO DE ÓLEO		1	1
60011680		KIT DE ARRUELAS		1	1
86101646		KIT DE BORRACHAS		1	1
86149640		KIT DE ARRUELAS E BORRACHAS DO JOGO SUPERIOR	1		

• VENDE-SE AVULSO

APLICAÇÃO

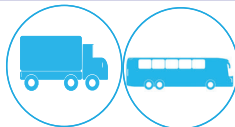

MERCEDES CAMINHÃO 608D/708D 1981/89

ÔNIBUS LO 608 1972/76

MERCEDES OM 314 4 CILINDROS 3.8L

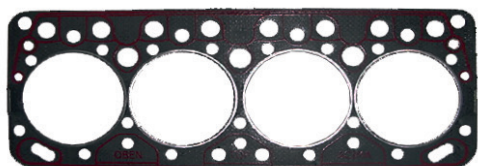

56108701-DIÂMETRO 98.5MM

56131803-DIÂMETRO 100 MM

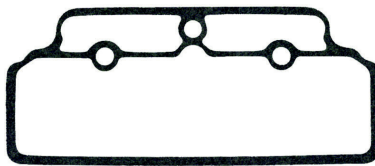

56111616

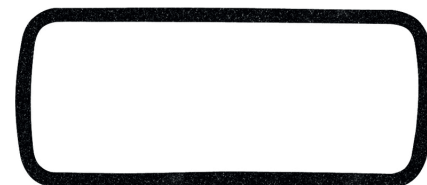

56111850

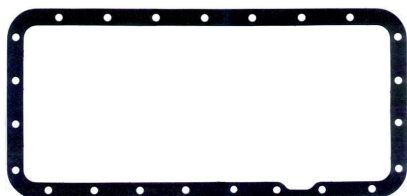

56111590



86115759



56134894



56112616



56110359



56100298



56110450



56106595



56106794

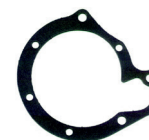

56109498



56109798



56100590



56102690



56100890



56109698



56110116



56109598



56109398



56109090



56114190



56106450



RE01810S



56112398



50051167

60011680		KIT DE ARRUELAS	
Nº ABR	DESCRIÇÃO		QTD
50012128	ARRUELA ALUMÍNIO 8,3 X 13,8 X 1,0MM		5
50014123	ARRUELA COBRE 9,5 X 20,0 X 1,0MM		4
50021229	ARRUELA ALUMÍNIO 14,0 X 13,8 X 1,5MM		2
50023329	ARRUELA ALUMÍNIO 16,20 X 22,0 X 1,5MM		2
50030425	ARRUELA ALUMÍNIO 26,0 X 32,0 X 2,0MM		2
50069329	ARRUELA ALUMÍNIO 20,2 X 24,0 X 1,5MM		1
50029723	ARRUELA DUPLA 8,0 X 12,0 X 1,0MM		4

86101646		KIT DE BORRACHA	
Nº ABR	DESCRIÇÃO		QTD
50005341	VADADOR 8,0 X 2,7MM		1
50035341	VEDADOR 31,5 X 3,8MM		4
50035441	ARRUELA BORRACHA 14,0 X 6,0 X 8,0MM		5
54386740	VEDADOR 12,5 X 2,6MM		1

86149640		KIT DE ARRUELAS E BORRACHA DO JOGO SUPERIOR	
Nº ABR	DESCRIÇÃO		QTD
50035441	VEDADOR 6,0 X 14,0 X 8,0MM		5
50014123	ARRUELA COBRE 9,5 X 20,0 X 1,00MM		4
56129723	ARRUELA DUPLA 8,0 X 12,0 X 1,00MM		4
50035341	VEDADOR 31,5 X 3,8MM		4

MERCEDES OM 364 4 CILINDROS 4.0L / OM 364A 4.0L TURBO

Nº JOGO		DESCRIÇÃO				
76121681		JOGO DE JUNTAS COMPLETO OM 364 COM JUNTA DE CABEÇOTE 98,5MM COM RETENTORES				1
76111681		JOGO DE JUNTAS COMPLETO OM 364 COM JUNTA DE CABEÇOTE 100,0MM COM RETENTORES				2
76121671		JOGO DE JUNTAS COMPLETO OM 364A COM JUNTA DE CABEÇOTE 98,5MM COM RETENTORES				3
76111671		JOGO DE JUNTAS COMPLETO OM 364A COM JUNTA DE CABEÇOTE 100,0MM COM RETENTORES				4
76131671		JOGO DE JUNTAS SUPERIOR OM 364 / OM 364A COM JUNTA DE CABEÇOTE 98,5MM COM RETENTORES				5
76131681		JOGO DE JUNTAS SUPERIOR OM 364 / OM 364A COM JUNTA DE CABEÇOTE 100,0MM COM RETENTORES				6
Nº ABR	Nº ORIGINAL	DESCRIÇÃO				
56108701	3640160320	JUNTA DO CABEÇOTE OM314 / 364 / 364A Ø 98,5 MM	1	1	1	1
56131803	3640160320	JUNTA DO CABEÇOTE OM314 / 364 / 364A Ø 100,0 MM	1	1	1	1
56131016	3640160021	JUNTA DA TAMPA DAS VÁLVULAS	1	1	1	1
56131231	3661420180	JUNTA DO COLETOR DE ESCAPAMENTO	3	3	3	3
56134716		JUNTA DO TUBO DE SAÍDA DO ESCAPAMENTO			1	1
86115759	3145860201	KIT DE JUNTAS DO CÂRTER (4 PEÇAS)			1	1
56126598	3520150520	JUNTA DIANTEIRA DA DISTRIBUIÇÃO			1	1
50051167	0009979641	GAXETA (CONJUNTO COM 2 PEÇAS)			1	1
RE01810S		RETENTOR DIANTEIRO DO VIRABREQUIM			1	1
56100590	3522030680	JUNTA DO CAVALETE DE ÁGUA	2	2	2	2
56100890	71511022006	JUNTA DA TUBULAÇÃO DE ÁGUA			1	1
56102690	000911280	JUNTA DA FLANGE DA BOMBA ALIMENTADORA			1	1
56106595	3120760279	JUNTA DA BOMBA INJETORA			1	1
56106794	3211310079	JUNTA DA CAMISA DO COMPRESSOR			1	1
56109498	3522010480	JUNTA DA CARÇA DA BOMBA DE ÁGUA			1	1
56110450	3120150680	JUNTA DA TAMPA DE INSPEÇÃO DA DISTRIBUIÇÃO			1	1
56111590	3420150080	JUNTA DO RADIADOR DE ÓLEO			1	1
56114190	3141840379	JUNTA DA FLANGE DO FILTRO DE ÓLEO			1	1
56127695	3141840179	JUNTA DO FILTRO DE ÓLEO			1	1
56128416	3521310280	JUNTA DO CABEÇOTE DO COMPRESSOR (MODERNO)			1	1
56129490	3662030080	JUNTA DO TERMOSTATO	1	1	1	1
56131316	3661410280	JUNTA DO COLETOR DE ADMISSÃO	2	2	2	2
56131941	3640150160	JUNTA DA TAMPA LATERAL DAS VÁLVULAS			1	1
56133590	3460180080	JUNTA DO TUBO DE ENCHIMENTO DE ÓLEO			1	1
56134894	3430150080	JUNTA TRASEIRA DA DISTRIBUIÇÃO			1	1
56139316	3521310380	JUNTA DO CABEÇOTE DO COMPRESSOR			1	1
56148390		JUNTA DO REFRIGERADOR DE ÓLEO			2	2
56148698	3641880080	JUNTA DO INTERCAMBIADOR			1	1
56149198	3030180079	JUNTA DO MEDIDOR DA VARETA DO ÓLEO			1	1
60011680		KIT DE ARRUELAS			1	1
86101646		KIT DE BORRACHAS			1	1
86120831		KIT DE JUNTAS DA TURBINA			1	1
86149640		KIT DE ARRUELAS E BORRACHAS DO JOGO SUPERIOR	1	1		

• VENDE-SE AVULSO

MERCEDES OM 364 4 CILINDROS 4.0L / OM 364A 4.0L TURBO

APLICAÇÃO

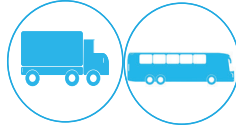

MERCEDES OM364 CAMINHÃO 709 1981/98;

MERCEDES OM364A CAMINHÃO 712 1995/99 ; 912 1987/95 ; 914 1994/99 ; 712 1992/03 ; 710 1992/12 ; 1214C 1997/99 ; 1114 1994/97

MERCEDES OM364A ÔNIBUS LO 610 2001/03 ; LO 712 2006/10 ; LO 812 1988/10 ; LO 813 1990/96 ; LO 814 1996/04 ; OF 812 1987/97

MERCEDES OM364 ÔNIBUS LO 809 1991/94

MERCEDES OM 364 4 CILINDROS 4.0L / OM 364A 4.0L TURBO

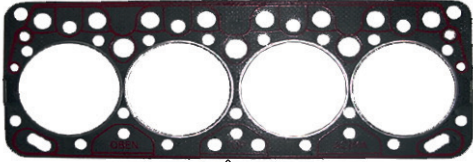

56108701-DIÂMETRO 98.5MM

56131803-DIÂMETRO 100 MM

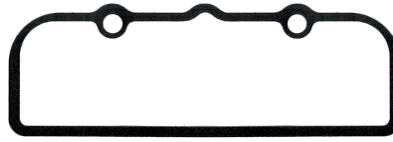

56131016



56131941

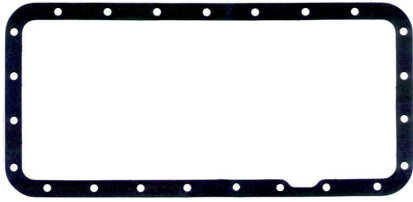

56111590



86115759



56134894



56126598

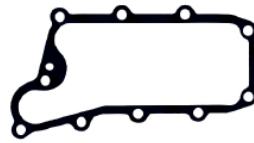

56148698

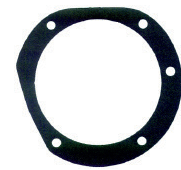

56106595



56131231



56128416



56131316



56109498



56130990



56100890



56100590



56134716



56106595



56102690



56133590



56129490



56127695



56114190



56109090



56110450



RE01810S



50051167

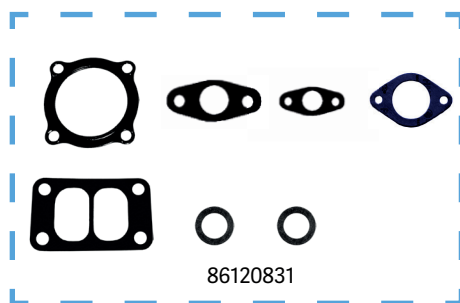

60011680		KIT DE ARRUELAS	
Nº ABR	DESCRIÇÃO	QTD	
50012128	ARRUELA ALUMÍNIO 8,3 X 13,8 X 1,0MM	5	
50014123	ARRUELA COBRE 9,5 X 20,0 X 1,0MM	4	
50021229	ARRUELA ALUMÍNIO 14,0 X 13,8 X 1,5MM	2	
50023329	ARRUELA ALUMÍNIO 16,20 X 22,0 X 1,5MM	2	
50030425	ARRUELA ALUMÍNIO 26,0 X 32,0 X 2,0MM	2	
50069329	ARRUELA ALUMÍNIO 20,2 X 24,0 X 1,5MM	1	
50029723	ARRUELA DUPLA 8,0 X 12,0 X 1,0MM	4	

86101646		KIT DE BORRACHA	
Nº ABR	DESCRIÇÃO	QTD	
50005341	VEDADOR 8,0 X 2,7MM	1	
50035341	VEDADOR 31,5 X 3,8MM	4	
50035441	ARRUELA BORRACHA 14,0 X 6,0 X 8,0MM	5	
54386740	VEDADOR 12,5 X 2,6MM	1	

86149640		KIT DE ARRUELA E BORRACHA DO JOGO SUPERIOR	
Nº ABR	DESCRIÇÃO	QTD	
50035441	VEDADOR 6,0 X 14,0 X 8,0 MM	5	
50014123	ARRUELA COBRE 9,5 X 20,0 X 1,0MM	4	
56129723	ARRUELA DUPLA 8,0 X 12,0 X 1,0MM	4	
50035341	VEDADOR 31,5 X 3,8 MM	4	

Nº JOGO		DESCRIÇÃO				
76141721		JOGO DE JUNTAS COMPLETO OM 352 COM JUNTA DE CABEÇOTE 98,5MM COM RETENTORES				1
76121721		JOGO DE JUNTAS COMPLETO OM 352 COM JUNTA DE CABEÇOTE 100,0MM COM RETENTORES				2
76141031		JOGO DE JUNTAS COMPLETO OM 352A/LA COM JUNTA DE CABEÇOTE 98,5MM COM RETENTORES				3
76121031		JOGO DE JUNTAS COMPLETO OM 352A/LA COM JUNTA DE CABEÇOTE 100,0MM COM RETENTORES				4
76131721		JOGO DE JUNTAS SUPERIOR 352A/LA COM JUNTA DE CABEÇOTE 98,5MM COM RETENTORES				5
76131031		JOGO DE JUNTAS SUPERIOR 352A/LA COM JUNTA DE CABEÇOTE 100,0MM COM RETENTORES				6
Nº ABR	Nº ORIGINAL	DESCRIÇÃO				
56149603	3520160220	JUNTA DO CABEÇOTE OM352 / 352A / 352LA / 366 / 366A / 366LA Ø 98,5 MM	1	1	1	1
56150201	3440167520	JUNTA DO CABEÇOTE OM352 / 352A / 352LA / 366 / 366A / 366LA Ø 100 MM	1	1	1	1
56110216	3520160421	JUNTA DA TAMPA DAS VÁLVULAS	1	1	1	1
86115531	3521420080	KIT DE JUNTAS DO COLETOR DE ESCAPAMENTO – TURBO / ASPIRADO	1	1	1	1
86112159	3445867001	KIT DE JUNTAS DO CÂRTER		1	1	1
56110359	3520150320	JUNTA DIANTEIRA DA DISTRIBUIÇÃO		1	1	1
56134894	3430150080	JUNTA TRASEIRA DA DISTRIBUIÇÃO		1	1	1
50051167	0009979641	GAXETA (CONJUNTO COM 2 PEÇAS)		1	1	1
RE01810S		RETENTOR DIAANTEIRO DO VIRABREQUIM		1	1	1
56100298	3211310279	JUNTA DO CABEÇOTE DO COMPRESSOR 77 MM		1	1	1
56100890	71511022006	JUNTA DA TUBULAÇÃO DE ÁGUA		1	1	1
56101216	302490080	JUNTA DO TUBO DE SAÍDA DO ESCAPAMENTO		1	1	
56102690	0000911280	JUNTA DA FLANGE DA BOMBA ALIMENTADORA		1	1	1
56106056	3520150522	JUNTA DA TAMPA LATERAL DAS VÁLVULAS		1	1	1
56106450	3120180280	JUNTA DA TAMPA DA TUBULAÇÃO DO ÓLEO		1	1	1
56106595	3120760279	JUNTA DA BOMBA INJETORA		1	1	1
56106794	3211310079	JUNTA DA CAMISA DO COMPRESSOR		1	1	1
56107716	3124921080	JUNTA DO TUBO DE SAÍDA DO ESCAPAMENTO				1
56109090	3271840280	JUNTA DA FLANGE DO FILTRO DE ÓLEO		1	1	1
56109398	3522010980	JUNTA DO SUPORTE DA BOMBA DE ÁGUA		1	1	1
56109498	3522010480	JUNTA DA CARÇAÇA DA BOMBA DE ÁGUA		1	1	1
56110450	3120150680	JUNTA DA TAMPA DE INSPEÇÃO DA DISTRIBUIÇÃO		1	1	1
56112298	3522011280	JUNTA DA BOMBA DE ÁGUA		1	1	1
56114190	3141840379	JUNTA DA FLANGE DO FILTRO DE ÓLEO		1	1	1
56128416	3521310280	JUNTA DO CABEÇOTE DO COMPRESSOR - MODERNO 94 MM		1	1	1
56139398	3521310380	JUNTA DO CABEÇOTE DO COMPRESSOR DE AR		1	1	1
56149098	3520180380	JUNTA DO TUBO DE RETORNO DE ÓLEO AO CÂRTER		1	1	1
60011720		KIT DE ARRUELA		1	1	1
86111175	445860018	KIT DE JUNTAS DO REFRIGERADOR DO ÓLEO		1	1	1
86120831		KIT DE JUNTAS DA TURBINA		1	1	
86124390		KIT DE JUNTAS DO REFRIGERADOR DE ÁGUA	1	1	1	1
SK861044		KIT DE BORRACHAS		1	1	1
86149726		KIT DE ARRUELAS DO JOGO SUPERIOR	1	1		
86149740		KIT DE BORRACHAS DO JOGO SUPERIOR	1	1		

• VENDE-SE AVULSO

APLICAÇÃO

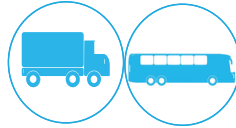

MERCEDES OM352 CAMINHÃO 1114 1981/90 ; 1113 1970/87 ; 1313/1513/2013 1970/89 ; 2213 1971/89;

MERCEDES OM352A/LA CAMINHÃO 2014 1975/89 ; 1514 1979/89 ; 1117 1981/90 ; 1316/1317/1516 1981/89 ; 1517 1986/87 ; 1518/2018 1981/91 ; 2216/2217 1981/87 ;

MERCEDES OM352 ÔNIBUS O 364 1978/84 ; OF 1113 1980/81 ; OF 1313/OH 1313 1970/86 ; OF 1314 1987/87

MERCEDES OM352A/LA ÔNIBUS O 365 1986/89 ; OF 1316 1982/86

MERCEDES OM 352 / OM 352A / OM 352LA 6 CILINDROS 5.7L

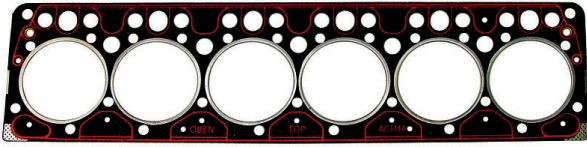

56149603-DIÂMETRO 98.5MM

56150201-DIÂMETRO 100 MM

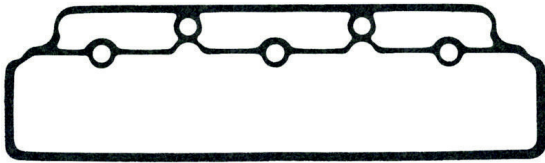

56110216



56106056

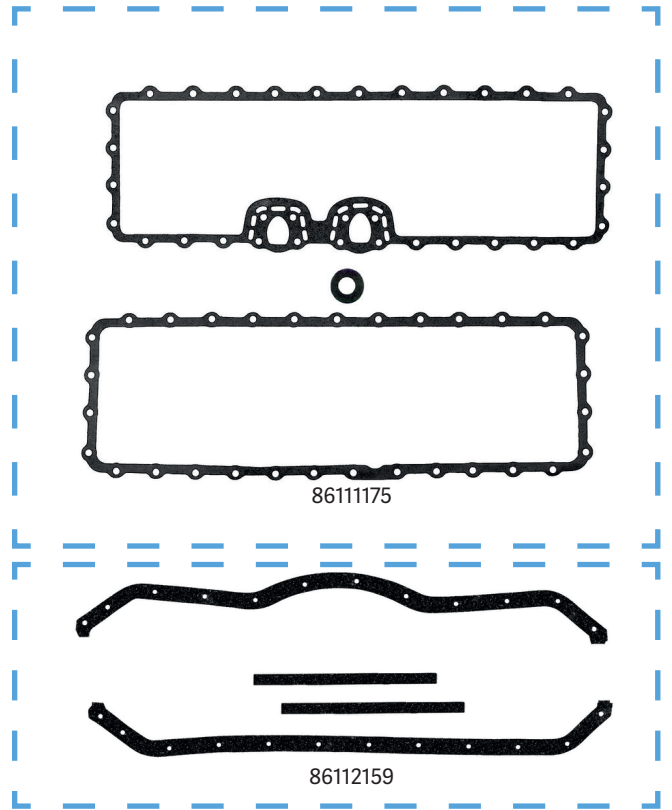

86111175

86112159

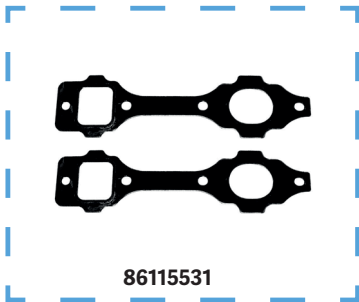

86115531



56110359



56126598



56134894



56128416



56100298



56106595



56109498



56101217



56107716



56149098



56106794



56102690



56110450

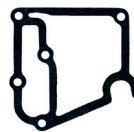

56112298

MERCEDES OM 352 / OM 352A / OM 352LA 6 CILINDROS 5.7L



56109398



56109090



56114190



RE01810S



56106450



50051167

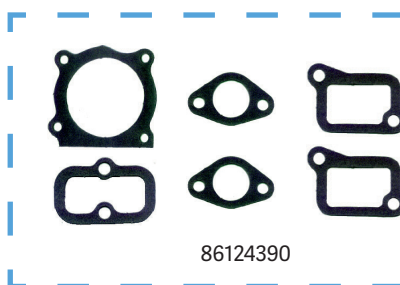

86124390

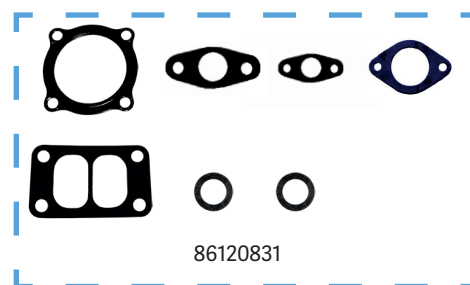

86120831

86149740 KIT DE BORRACHA DO JOGO SUPERIOR		
Nº ABR	DESCRIÇÃO	QTD
50035441	VEDADOR 6,0 X 14,0 X 8,0 MM	7
50035341	VEDADOR 31,5 X 3,8 MM	6

86149726 KIT DE ARRUELA DO JOGO SUPERIOR		
Nº ABR	DESCRIÇÃO	QTD
50014123	ARRUELA DE COBRE 9,5 X 20,0 X 1,0MM	6
56129723	ARRUELA DUPLA 8,0 X 12,0 X 1,0MM	6

60011720 KIT DE ARRUELA DO JOGO SUPERIOR		
Nº ABR	DESCRIÇÃO	QTD
	ARRUELA DE ALUMÍNIO 26,2X32,0 X1,5 MM	1
50011238	ARRUELA DE AÇO 8,0 X 12,0 X 1,0 MM	16
50011428	ARRUELA DE ALUMÍNIO 8,1 X 13,8 X 1,0 MM	6
50013860	ARRUELA DE FIBRA 9,0 X 18,0 X 0,4 MM	4
50014123	ARRUELA DE COBRE 9,5 X 20,0 X 1,0 MM	6
50015428	ARRUELA DE ALUMÍNIO 10,2 X 14,0 X 1,0 MM	6
50021129	ARRUELA DE ALUMÍNIO 14,0 X 18,0 X 1,5 MM	1
50021229	ARRUELA DE ALUMÍNIO 14,0 X 20,0 X 1,5 MM	18
50023329	ARRUELA DE ALUMÍNIO 16,2 X 22,0 X 1,5 MM	6
50025424	ARRUELA DE COBRE 18,3 X 23,8 X 1,5 MM	2
	ARRUELA DE ALUMÍNIO 24,3 X 30,0 X 1,5 MM	1
50030425	ARRUELA DE ALUMÍNIO 26,0 X 32,0 X 2,0 MM	1
50069229	ARRUELA DE ALUMÍNIO 18,2 X 21,9 X 1,5 MM	3
50072429	ARRUELA DE ALUMÍNIO 22,5 X 26,7 X 1,5 MM	1
56129723	ARRUELA DUPLA 8,0 X 12,0 X 1,0 MM	6

SK861044 KIT DE BORRACHA		
Nº ABR	DESCRIÇÃO	QTD
	VEDADOR 30,80X3,70MM	6
	VEDADOR 62,00X3,00MM	1
	VEDADOR 28,30X2,00MM	1
	VEDADOR 8,30X2,50MM	1
	VEDADOR 13,10X2,62MM	1
	VEDADOR 115,00X5,00MM	1
	VEDADOR 105,00X95,00X3,00MM	1
	VEDADOR 14,00X6,00X8,00MM	7
	VEDADOR 23,70X14,20X6,30MM	1
	VEDADOR 27,90X13,80X10,50MM	1

Nº JOGO		DESCRIÇÃO			
66113121 3555860290		JOGO DE JUNTAS COMPLETO OM 355/5 CILINDROS ASPIRADO / TURBO SEM RETENTORES	1		
76113121 3555860290		JOGO DE JUNTAS COMPLETO OM 355/5 CILINDROS ASPIRADO / TURBO COM RETENTORES	2		
76133121		JOGO DE JUNTAS SUPERIOR OM 355/5 CILINDROS ASPIRADO / TURBO COM RETENTORES	3		
Nº ABR	Nº ORIGINAL	DESCRIÇÃO			
56111903	3550160220	JUNTA DO CABEÇOTE – OM 355 3 CILINDROS Ø 133MM	1	1	1
56119803	3450160020	JUNTA DO CABEÇOTE – OM 355 2 CILINDROS Ø 133MM	1	1	1
56123503	3460160320	JUNTA DO CABEÇOTE – OM 355 1 CILINDROS Ø 133MM			
RE01860N		RETENTOR BOMBA INJETORA		1	
56111796	3460160022	JUNTA DA TAMPA DAS VÁLVULAS	5	5	5
86137816		KIT DE JUNTAS DO COLETOR DE ADMISSÃO 5 CILINDRO	1	1	1
86119790		KIT DE JUNTAS DO CÂRTER – OM 355 5 CILINDROS		1	1
56116359	3460150120	JUNTA DA TAMPA DE INSPEÇÃO DA DISTRIBUIÇÃO		1	1
RE00269S		RETENTOR TRASEIRO DO VIRABREQUIM		1	
RE01815F		RETENTOR HASTE DAS VÁLVULAS	20	20	
54117583	304334.0059	JUNTA DO SEMI-EIXO		1	1
56101139	3451420080	JUNTA DO COLETOR DO ESCAPAMENTO	5	5	5
56101216	3024900080	JUNTA DA SAÍDA DO ESCAPAMENTO		1	1
56101317	3444920080	JUNTA DA SAÍDA DO ESCAPAMENTO		1	1
56101490	3151840180	JUNTA DA TAMPA DO FILTRO DE ÓLEO		1	1
56101590	3262030080	JUNTA DA BOMBA DE ÁGUA		1	1
56101790	3152010180	JUNTA DA TAMPA DA BOMBA DE ÁGUA		1	1
56102294	0651810079	JUNTA DO SUPORTE DA BOMBA DE ÓLEO		1	1
56113950	3520180180	JUNTA DA TAMPA DO TUBO DO ÓLEO		1	1
56117890	356201.0180	JUNTA DA CARÇA DA BOMBA DE ÁGUA		1	1
56118090	3551840480	JUNTA DO SUPORTE DO FILTRO DE ÓLEO		1	1
56118190	3551880080	JUNTA DA CARÇA DO REFRIGERADOR DE ÓLEO		1	1
56118290	0001311679	JUNTA DO COMPRESSOR DE AR (SUPERIOR)		1	1
56118390	0001311579	JUNTA DO COMPRESSOR DE AR (INFERIOR)	2	2	
56118416	0001314380	JUNTA DO CABEÇOTE DO COMPRESSOR		1	1
56118590	0011311479	JUNTA DO SUPORTE DO COMPRESSOR DE AR		1	1
56118690	3460770380	JUNTA DO SUPORTE DA BOMBA INJETORA	2	2	
56118990	071511040017	JUNTA DO TUBO DE VENTILAÇÃO		1	1
56119090		JUNTA DA CARÇA DA BOMBA INJETORA	6	6	
56119290	0000911280	JUNTA DA FLANGE DA BOMBA ALIMENTADORA		1	1
56119690	3540150021	JUNTA DA TAMPA DOS CILINDROS OM 355 5 CILINDROS		1	1
56120190	071511026003	JUNTA DA TAMPA DA BOMBA DE ÓLEO		1	1
56122298	3450150022	JUNTA DA TAMPA LATERAL DAS VÁLVULAS		1	1
56133590	3460180080	JUNTA DO TUBO DE ENCHIMENTO DE ÓLEO		1	1
60013120		KIT DE ARRUELAS 5 CILINDROS		1	1
83721017		KIT DE JUNTAS DA TURBINA		1	1
86100846		KIT DE BORRACHA 5 CILINDROS		1	1
86117690	0001303920	KIT DE JUNTAS DO COMPRESSOR DE AR		1	1
86130890		KIT DE JUNTAS DA REFRIGERAÇÃO DE ÁGUA	1		
86149940		KIT DE ARRUELAS E BORRACHAS DO JOGO SUPERIOR OM 355 / 5 CILINDROS	1		

• VENDE-SE AVULSO

MERCEDES OM 355/5 CILINDROS 20V 9.7L

APLICAÇÃO

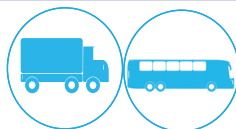

MERCEDES CAMINHÃO 1519 1973/89 ; 1520 1981/90 ; 2220 1987/91 ; 2219 1977/89 ; 1525 1985/90 ; 2225 1989/89

MERCEDES ÔNIBUS O 364 1978/86 ; O 370R 1984/87 ; O371 R 1987/90 ; O 371 UP 1987/93 ; OH 1419/OH 1517 1976/86

MERCEDES OM 355/5 CILINDROS 20V 9.7L



56111903 - DIÂMETRO 133MM



56119803 - DIÂMETRO 133MM

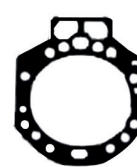

56123503 - DIÂMETRO 133MM



56119690



56111796



56117990



56122298

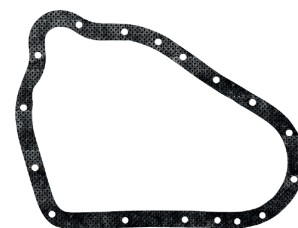

56116359

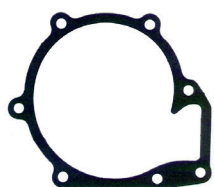

56117890

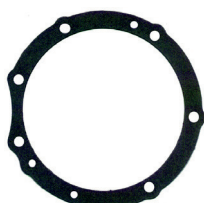

56118690



54117583

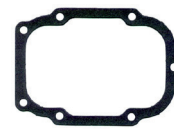

56118190



56119090



56118990



56102294



56101139



56101216



56101317



56101590



56133590



56119190



56118390



5618290



56119290



56118416



56101490



RE00269S



RE01860N



56118090



56113950



RE01815F

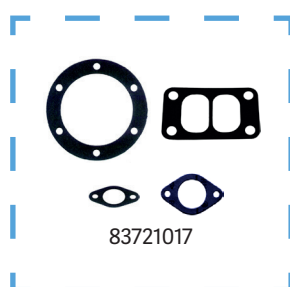
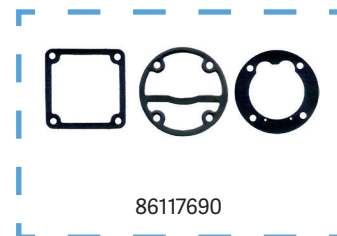
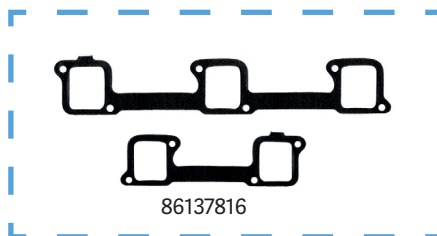
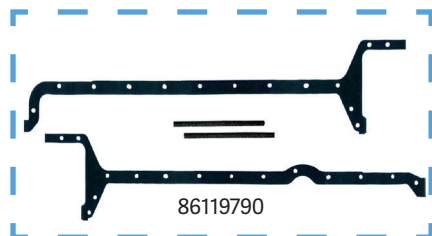

60013120		KIT DE ARRUELA	
Nº ABR	DESCRIÇÃO	QTD	
50034920	ARRUELA DE COBRE 35,3 X 41,0 X 2,0MM	7	
56129723	ARRUELA DE DUPLA 8,0 X 12,0 X 1,0MM	5	
50032729	ARRUELA DE ALUMÍNIO 30,3 X 35,9 X 1,50MM	2	
50012128	ARRUELA DE ALUMÍNIO 8,3 X 13,8 X 1,0MM	15	
50012928	ARRUELA DE ALUMÍNIO 8,3 X 11,4 X 1,0MM	12	
50021229	ARRUELA DE ALUMÍNIO 14,0 X 20,0 X 1,5MM	12	
50072429	ARRUELA DE ALUMÍNIO 22,5 X 26,7 X 1,5MM	6	
50027329	ARRUELA DE ALUMÍNIO 20,5 X 25,9 X 1,50MM	2	
50070329	ARRUELA DE ALUMÍNIO 18,5 X 21,7 X 1,5MM	2	
50023329	ARRUELA DE ALUMÍNIO 16,2 X 22,0 X 1,5MM	2	
50029525	ARRUELA DE ALUMÍNIO 24,2 X 29,4 X 2,0MM	2	
50021429	ARRUELA DE ALUMÍNIO 1 4,2 X 18,0 X 1,50MM	1	
50014123	ARRUELA DE COBRE 9,5 X 20,0 X 1,0MM	5	

86100846		KIT DE BORRACHAS	
Nº ABR	DESCRIÇÃO	QTD	
50007841	VEDADOR 27,0X3,3MM	2	
50028441	VEDADOR 117,0X4,8MM	1	
50035341	VEDADOR 30,8X3,7MM	5	
54386740	VEDADOR 12,5X2,6MM	1	
50040041	VEDADOR 18,0X2,5MM	1	
50002841	TUBO ARREFECIMENTO	5	
50003041	COLETOR ADMISSÃO	1	

86149940		KIT DE BORRACHAS	
Nº ABR	DESCRIÇÃO	QTD	
56129723	ARRUELA DUPLA 8,0 X 12,0 X 1,0MM	5	
50014123	ARRUELA COBRE 9,5 X 20,0 X 1,0MM	5	
50002841	ANEL VEDAÇÃO DO ARREFECIMENTO	5	
50003041	ANEL VEDAÇÃO DO COLETOR DE ADMISSÃO	1	

Nº JOGO		DESCRIÇÃO			
66112501 3555860290		JOGO DE JUNTAS COMPLETO OM 355/6 CILINDROS ASPIRADO / TURBO SEM RETENTORES	1		
76112501 3555860290		JOGO DE JUNTAS COMPLETO OM 355/6 CILINDROS ASPIRADO / TURBO COM RETENTORES	2		
76132501		JOGO DE JUNTAS SUPERIOR OM 355/6 CILINDROS ASPIRADO / TURBO COM RETENTORES	3		
Nº ABR	Nº ORIGINAL	DESCRIÇÃO			
56111903	3550160220	JUNTA DO CABEÇOTE – OM 355 3 CILINDROS Ø 133MM	2	2	2
56123503	3460160320	JUNTA DO CABEÇOTE – OM 355 1 CILINDRO Ø 133MM			
56111796	3460160022	JUNTA DA TAMPA DAS VÁLVULAS	6	6	6
86137716		KIT DE JUNTAS DO COLETOR DE ADMISSÃO 6 CILINDROS	1	1	1
86116190		KIT DE JUNTAS DO CÂRTER – OM 355 6 CILINDROS		1	1
56116359	3460150120	JUNTA DA TAMPA DE INSPEÇÃO DA DISTRIBUIÇÃO		1	1
RE00269S		RETENTOR TRASEIRO DO VIRABREQUIM		1	
RE01815F		RETENTOR HASTE DAS VÁLVULAS	24	24	
RE01860N		RETENTOR BOMBA INJETORA		1	
54117583	3043340059	JUNTA DO SEMI-EIXO		1	1
56101139	3451420080	JUNTA DO COLETOR DO ESCAPAMENTO	6	6	6
56101216	3024900080	JUNTA DA SAÍDA DO ESCAPAMENTO		1	1
56101317	3444920080	JUNTA DA SAÍDA DO ESCAPAMENTO		1	1
56101490	3151840180	JUNTA DA TAMPA DO FILTRO DE ÓLEO		1	1
56101590	326.2030080	JUNTA DA BOMBA DE ÁGUA		1	1
56101790	3152010180	JUNTA DA TAMPA DA BOMBA DE ÁGUA		1	1
56102294	0651810079	JUNTA DO SUPORTE DA BOMBA DE ÓLEO		1	1
56113950	3520180180	JUNTA DA TAMPA DO TUBO DO ÓLEO		1	1
56117790	3560150121	JUNTA DA TAMPA DOS CILINDROS OM 355 6 CILINDROS		1	1
56117890	3562010180	JUNTA DA CARÇA DA BOMBA DE ÁGUA		1	1
56117990	3550150022	JUNTA DA TAMPA LATERAL DAS VÁLVULAS		1	1
56118090	3551840480	JUNTA DO SUPORTE DO FILTRO DE ÓLEO		1	1
56118190	3551880080	JUNTA DA CARÇA DO REFRIGERADOR DE ÓLEO		1	1
56118290	0001311679	JUNTA DO COMPRESSOR DE AR (SUPERIOR)		1	1
56118390	0001311579	JUNTA DO COMPRESSOR DE AR (INFERIOR)	2	2	
56118416	0001314380	JUNTA DO CABEÇOTE DO COMPRESSOR		1	1
56118590	0011311479	JUNTA DO SUPORTE DO COMPRESSOR DE AR		1	1
56118690	3460770380	JUNTA DO SUPORTE DA BOMBA INJETORA	2	2	
56118990	071511040017	JUNTA DO TUBO DE VENTILAÇÃO		1	1
56119090		JUNTA DA CARÇA DA BOMBA INJETORA	6	6	
56119190	3030180079	JUNTA DA BOMBA DE ÓLEO		1	1
56119290	0000911280	JUNTA DA FLANGE DA BOMBA ALIMENTADORA		1	1
56120190	071511026003	JUNTA DA TAMPA DA BOMBA DE ÓLEO		1	1
56133590	3460180080	JUNTA DO TUBO DE ENCHIMENTO DE ÓLEO		1	1
60012500		KIT DE ARRUELAS 6 CILINDROS		1	1
83721017		KIT DE JUNTAS DA TURBINA		1	1
86100946		KIT DE BORRACHA 6 CILINDROS		1	1
86117690	0001303920	KIT DE JUNTAS DO COMPRESSOR DE AR		1	1
86130890		KIT DE JUNTAS DA REFRIGERAÇÃO DE ÁGUA	1		
86149840		KIT DE ARRUELAS E BORRACHAS JOGO SUPERIOR OM 355 / 6 CILINDROS	1		

• VENDE-SE AVULSO

MERCEDES OM 355/6 CILINDROS 24V 11.6L

APLICAÇÃO



MERCEDES CAMINHÃO 1524 1985/89 ; 1924 1974/87 ; 2624 1974/...1525 1985/90 ; 2225 1989/89 ; 929 1984/87 ; 1932/1933 1984/89 1934 1987/89 ;

MERCEDES ÔNIBUS O 355 1972/75 ; O 370 RS/O 370 RSD 1976/90 ; OH 1420 1972/86

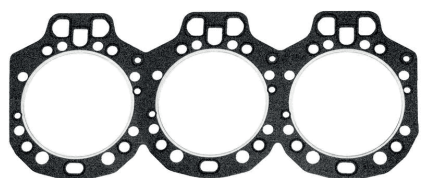

56111903 - DIÂMENTRO 133 MM

56123503 - DIÂMENTRO 133 MM

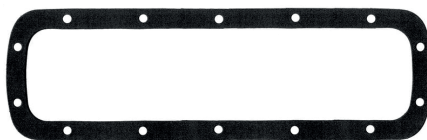

56117990



56111796



56117790



54117583

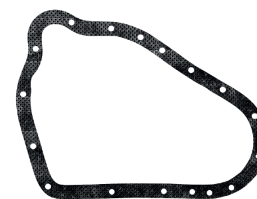

56116359



56118690



56123503

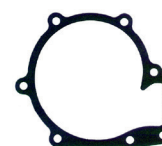

56117890



56118390



56118290

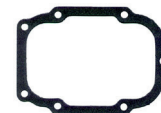

56118190



56118990



56119090



56119190



56120190



56102294



56101139



56101216



56118090



56101590



56119290



56118416



56133590



561011490



56113950



RE00269S



RE01860N



RE01815F

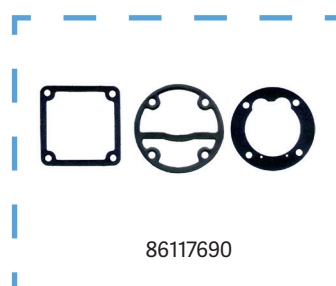
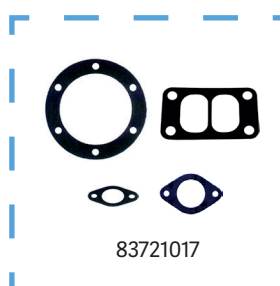
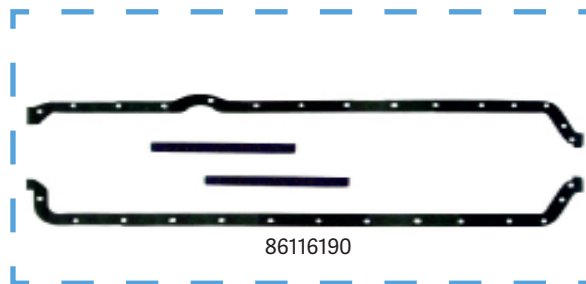
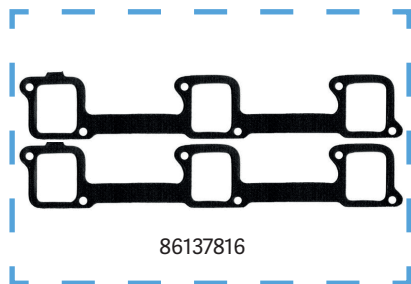

60012500		KIT DE ARRUELAS	
Nº ABR	DESCRIÇÃO		QTD
50034920	ARRUELA DE COBRE 35,3 X 41,0 X 2,0MM		7
56129723	ARRUELA DUPLA 8,0 X 12,0 X 1,0MM		6
50032729	ARRUELA DE ALUMÍNIO 30,3 X 35,9 X 1,50MM		2
50012128	ARRUELA DE ALUMÍNIO 8,3 X 13,8 X 1,0MM		18
50012928	ARRUELA DE ALUMÍNIO 8,3 X 11,4 X 1,0MM		14
50021229	ARRUELA DE ALUMÍNIO 14,0 X 20,0 X 1,5MM		14
50092728	ARRUELA DE ALUMÍNIO 12,5 X 15,9 X 1,0MM		6
50072429	ARRUELA DE ALUMÍNIO 22,5 X 26,7 X 1,5MM		6
50027329	ARRUELA DE ALUMÍNIO 20,5 X 25,9 X 1,50MM		2
50070329	ARRUELA DE ALUMÍNIO 18,5 X 21,7 X 1,5MM		2
50023329	ARRUELA DE ALUMÍNIO 16,2 X 22,0 X 1,5MM		2
50029525	ARRUELA DE ALUMÍNIO 24,2 X 29,4 X 2,0MM		2
50021429	ARRUELA DE ALUMÍNIO 14,2 X 18,0 X 1,50MM		2
50014123	ARRUELA DE COBRE 9,5 X 20,0 X 1,0MM		6

86149840		KIT DE ARRUELAS E BORRACHA DO JOGO SUPERIOR	
Nº ABR	DESCRIÇÃO		QTD
56129723	ARRUELA DUPLA 8,0 X 12,0 X 1,0 MM		6
50014123	ARRUELA DE COBRE 9,5 X 20,0 X 1,0 MM		6
50002841	ANEL DE VEDAÇÃO DO ARREFECIMENTO		6
50003041	ANEL DE VEDAÇÃO DO COLETOR DE ADMISSÃ		1

Nº JOGO	DESCRIÇÃO
76121691	445800095 JOGO DE JUNTAS COMPLETO OM 366 COM JUNTA DE CABEÇOTE 98,5MM COM RETENTORES
76111691	445800095 JOGO DE JUNTAS COMPLETO OM 366 COM JUNTA DE CABEÇOTE 100,0MM COM RETENTORES
76121701	3660100380/3308 JOGO DE JUNTAS COMPLETO OM 366A COM JUNTA DE CABEÇOTE 98,5MM COM RETENTORES
76141701	3660100380/3308 JOGO DE JUNTAS COMPLETO OM 366A COM JUNTA DE CABEÇOTE 100,0MM COM RETENTORES
761212791	JOGO DE JUNTAS COMPLETO OM 366LA COM JUNTA DE CABEÇOTE 100,0MM COM RETENTORES
76131701	JOGO DE JUNTAS SUPERIOR 366/A/LA COM JUNTA DE CABEÇOTE 98,5MM COM RETENTORES
76131691	JOGO DE JUNTAS SUPERIOR 366/A/LA COM JUNTA DE CABEÇOTE 100,0MM COM RETENTORES

Nº ABR	Nº ORIGINAL	DESCRIÇÃO	1	2	3	4	5	6	7
56149603	35201602.20	JUNTA DO CABEÇOTE OM352 / 352A / 352LA /366 / 366A / 366LA Ø 98,5 MM		1			1		1
56150201	3440167520	JUNTA DO CABEÇOTE OM352 / 352A / 352LA / 366 / 366A / 366LA Ø 100,0 MM	1		1	1		1	
56130516	3660160021	JUNTA DA TAMPA DAS VÁLVULAS	1	1	1	1	1	1	1
56131231	3661420180	JUNTA DO COLETOR DE ESCAPAMENTO	4	4	4	4	4	4	4
56131316	3661410280	JUNTA DO COLETOR DE ADMISSÃO	3	3	3	3	3	3	3
86112159	3445867001	KIT DE JUNTAS DO CÂRTER			1	1	1	1	1
56151280	3660150020	JUNTA CAIXA DISTRIBUIÇÃO OM 366 LA BOMBA "P"			1				
56170167	3660150020	JUNTA CAIXA DISTRIBUIÇÃO OM 366 LA BOMBA "A"			1				
56126598	3520150520	JUNTA DIANTEIRA DA DISTRIBUIÇÃO			1	1	1	1	1
50051167	0009979641	GAXETA (CONJUNTO COM 2 PEÇAS)			1	1	1	1	1
RE01810S		RETENTOR DIANTEIRO DO VIRABREQUIM			1	1	1	1	1
56100590	3522030680	JUNTA DO CAVALETE DE ÁGUA	2	2	2	2	2	2	2
56100890	71511022006	JUNTA DA TUBULAÇÃO DE ÁGUA			1	1	1	1	1
56102690	0000911280	JUNTA DA FLANGE DA BOMBA ALIMENTADORA			1	1	1	1	1
56106595	3120760279	JUNTA DA BOMBA INJETORA			1	1	1	1	1
56106794	3124921080	JUNTA DA CAMISA DO COMPRESSOR - IMPORTADO			1	1	1	1	1
56109498	3522010480	JUNTA DA CARÇAÇA DA BOMBA DE ÁGUA			1	1	1	1	1
56110450	3120150680	JUNTA DA TAMPA DA DISTRIBUIÇÃO			1	1	1	1	1
56114190	3141840379	JUNTA DA FLANGE DO FILTRO DE ÓLEO			1	1	1	1	1
56127695	3141840179	JUNTA DO FILTRO DE ÓLEO			1	1	1	1	1
56128416	3521310380	JUNTA DO CABEÇOTE DO COMPRESSOR (MODERNO) 94,0 MM			1	1	1	1	1
56129490	3662030080	JUNTA DO TERMOSTATO	1	1	1	1	1	1	1
56129532	3622010080	JUNTA DA BOMBA DE ÁGUA			1	1	1	1	1
56130616	3504920080	JUNTA DA SAÍDA DO ESCAPAMENTO			1	1	1	1	1
56130990	3440160080	JUNTA DA FLANGE DE ASPIRAÇÃO DA TAMPA DAS VÁLVULAS			1	1	1	1	1
56131141	3520150160	JUNTA DA TAMPA LATERAL DAS VÁLVULAS			1	1	1	1	1
56133590	3460180080	JUNTA DO TUBO DE ENCHIMENTO DE ÓLEO			1	1	1	1	1
56134894	3430150080	JUNTA TRASEIRA DA DISTRIBUIÇÃO			1	1	1	1	1
56138294	3622010180	JUNTA DO SUPORTE DA BOMBA DE ÁGUA			1	1	1	1	1
56139398	3521310380	JUNTA DO CABEÇOTE DO COMPRESSOR DE AR			1	1	1	1	1
56143990	3520180980	JUNTA DO MEDIDOR DA VARETA DO ÓLEO			1	1	1	1	1
56148390		JUNTA DO REFRIGERADOR DE ÓLEO			2	2	2	2	2
56149198	3030180079	JUNTA DO MEDIDOR DA VARETA DO ÓLEO			1	1	1	1	1
60011720		KIT DE ARRUELAS			1	1	1	1	1
86120831		KIT DE JUNTAS DA TURBINA			1	1	1		
86126675	3621800079	KIT DE JUNTAS DO RADIADOR DE ÓLEO			1	1	1	1	1
86148940		KIT DE BORRACHAS			1	1	1	1	1
86149740		KIT DE ARRUELAS E BORRACHAS DO JOGO SUPERIOR	1	1					

• VENDE-SE AVULSO

APLICAÇÃO



MERCEDES 366 CAMINHÃO 2217 1987/90 ; 1314/2216 1987/89 ; 1214 1989/96 ; 1714 1991/96 ; 1414/1614 1989/96 ; 2214 1987/89 2314 1990/94 ;

MERCEDES 366A CAMINHÃO 1218 1989/00 ; 1318 1989/03 ; 1118 1987/90 ; 2318/2418 1990/99 ; 1718 1991/99 ; 1618 1981/96 ; 1418 1989/00

MERCEDES 366LA CAMINHÃO 1721 1991/98 ; 1621 1987/97 ; 1420 2002/05 ; 1720 1997/06 ; 1723 1997/01 ; 1620 1993/05

MERCEDES 366 ÔNIBUS OF 1315 1988/94 ; O 371 ST 1988/94 ; OH 1315 1988/95 ; OF 1115 1988/92

MERCEDES 366A ÔNIBUS O 371 U 1987/94 ; OF 1618 1992/94 ; OH 1318 1988/97 ; OF 1318 1988/07 ; OF 1620 1995/99 ;

OF 1721 1998/05 OH 1420 1998/03 ; OH 1420 1998/03 ; O 371 UL 1994/97 ; OH 1421/OH 1521/OH 1623 LG 1998/04 ; OH 1621/L/LE 1997/05

MERCEDES OM 366 CILINDROS 6.0L /366A/366LA 6 CILINDROS 6.0L TURBO

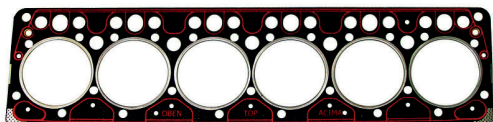

56149603-DIÂMETRO 98.5MM

56150201-DIÂMETRO 100 MM



56130516



56131141



56106595



56109498

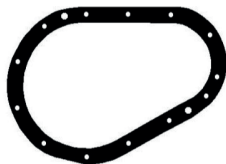

56126598



56151280



56170167



56134894



56130616



56131231



56131316



56143990



56148390



56149198



56100590



58130990



56102690



56128416



56139398



56106794



56110450



56133590



56114190



56127695



56138294



56129490

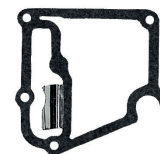

56129532



RE01810S



50051167

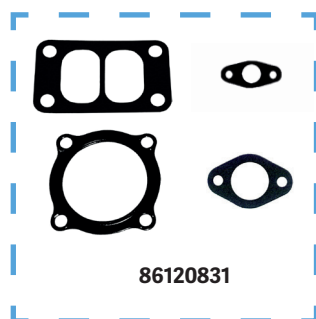
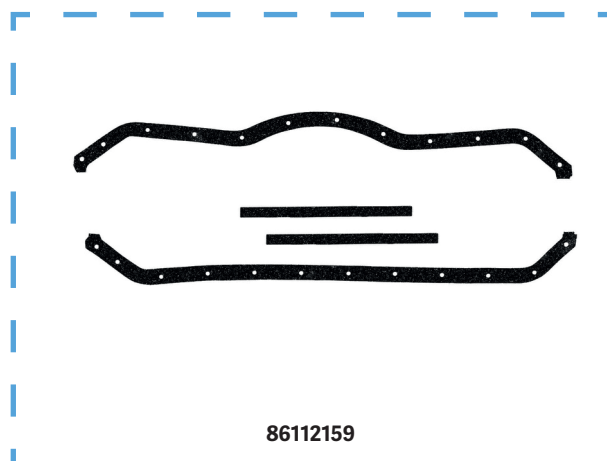
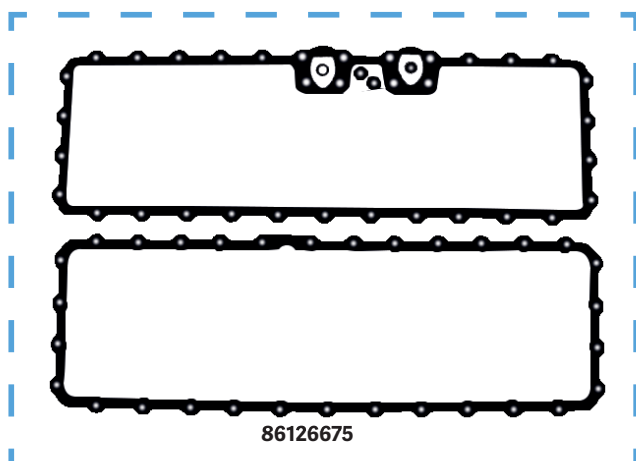

86149740 KIT DE ARRUELAS E BORRACHA DO JOGO SUPERIOR			
Nº ABR	DESCRIÇÃO	QTD	
50014123	ARRUELA DUPLA 8,0 X 12,0 X 1,0MM	6	
56129723	ARRUELA DE COBRE 9,5 X 20,0 X 1,0MM	6	
50035441	ANEL DE VEDAÇÃO DO ARREFECIMENTO	7	
50035341	ANEL DE VEDAÇÃO DO COLETOR DE ADMISSÃO	6	

60011720 KIT DE ARRUELA DO JOGO SUPERIOR			
Nº ABR	DESCRIÇÃO	QTD	
	ARRUELA DE ALUMÍNIO 26,2 X 32,0 X 1,5MM	1	
50011238	ARRUELA DE AÇO 8,0 X 12,0 X 1,0MM	16	
50011438	ARRUELA DE ALUMÍNIO 8,1 X 13,8 X 1,0MM	6	
50013860	ARRUELA DE FIBRA 9,0 X 18,0 X 0,4MM	4	
50014123	ARRUELA DE COBRE 9,5 X 20,0 X 1,0MM	6	
50015428	ARRUELA DE ALUMÍNIO 10,2 X 14,0 X 1,0MM	6	
50021129	ARRUELA DE ALUMÍNIO 14,0 X 18,0 X 1,5MM	1	
50021229	ARRUELA DE ALUMÍNIO 14,0 X 20,0 X 1,5MM	18	
50023329	ARRUELA DE ALUMÍNIO 16,2 X 22,0 X 1,5MM	6	
50025424	ARRUELA DE COBRE 18,3 X 23,8 X 1,5MM	2	
	ARRUELA DE ALUMÍNIO 24,3 X 30,0 X 1,5MM	1	
50030425	ARRUELA DE ALUMÍNIO 26,0 X 32,0 X 2,0MM	1	
50069229	ARRUELA DE ALUMÍNIO 18,2 X 21,9 X 1,5MM	3	
50072429	ARRUELA DE ALUMÍNIO 22,5 X 26,7 X 1,5MM	1	
56129723	ARRUELA DUPLA 8,0 X 12,0 X 1,0MM	6	

86148940 KIT DE BORRACHAS			
Nº ABR	DESCRIÇÃO	QTD	
	ANEL BORRACHA 30,8 X 3,7MM	6	
	ANEL BORRACHA 34,0 X 4,0MM	2	
	ANEL BORRACHA 8,3 X 2,5MM	4	
	ANEL BORRACHA 60 X 4,2MM	1	
	ANEL BORRACHA 45,0 X 4,0MM	2	
	ANEL BORRACHA 13,1 X 2,6MM	1	
	ANEL BORRACHA 28,5 X 2,5MM	1	
	ANEL BORRACHA 62,0 X 3,0MM	1	
	ANEL BORRACHA 75,0 X 3,0MM	1	
	ANEL BORRACHA 101,0 X 4,3MM	2	
	ANEL BORRACHA 14,0 X 7,5MM	7	
	ANEL BORRACHA 14,0 X 23,7 X 6,3MM	1	

Nº JOGO	DESCRIÇÃO					
76196115	JOGO DE JUNTAS COMPLETO OM 447A/447LA 6 CIL COM ANÉIS DE CAMISAS COM RETENTORES					1
66196115	JOGO DE JUNTAS COMPLETO OM 447A/447LA 6 CIL COM ANÉIS DE CAMISAS SEM RETENTORES					2
76196125	JOGO DE JUNTAS COMPLETO OM 449A/449LA 5 CIL COM ANÉIS DE CAMISAS COM RETENTORES					3
66196125	JOGO DE JUNTAS COMPLETO OM 449A/449LA 5 CIL COM ANÉIS DE CAMISAS SEM RETENTORES					4
76136125	JOGO DE JUNTAS MONOCILÍNDRICO OM447 / OM449 COM RETENTORES DE HASTES DE VÁLVULAS					5
66136125	JOGO DE JUNTAS MONOCILÍNDRICO OM447 / OM449 SEM RETENTORES DE HASTES DE VÁLVULAS					6

Nº ABR	Nº ORIGINAL	DESCRIÇÃO							
56137200	4220160420	JUNTA DO CABEÇOTE OM447 / OM449	1	1	5	5	6	6	
56130490		JUNTA DA TAMPA DAS VÁLVULAS	1	1	5	5	6	6	
56139239	4031420380	JUNTA DO COLETOR DE ESCAPAMENTO	1	1	5	5	6	6	
56141317		JUNTA DO COLETOR DE ADMISSÃO	1	1	5	5	6	6	
56151067	4050140222	JUNTA DO CÂRTER OM449 - 5 CILINDROS			1	1			
56151167	4070140222	JUNTA DO CÂRTER OM447 - 6 CILINDROS							1 1
56132298	4030110080	JUNTA DA TAMPA DIANTEIRA DO BLOCO			1	1	1	1	
56142398	4290150080	JUNTA DA TAMPA DA DISTRIBUIÇÃO							1 1
RE02697F		RETENTOR TRASEIRO DO VIRABREQUIM							1 1
RE02696F		RETENTOR DIANTEIRO DO VIRABREQUIM							1 1
RE02786F		RETENTOR DA HASTE DAS VÁLVULAS		2		10			12
50014123	3460170160	ARRUELA DO BICO INJETOR	1	1	5	5	6	6	
54308398	623208520044	JUNTA DA SAÍDA DO ÓLEO			1	1	1	1	
54308490	623208520064	JUNTA DA ENTRADA DO ÓLEO			1	1	1	1	
56128690	4030180180	JUNTA DA TAMPA DE ABASTECIMENTO DO ÓLEO DO CÂRTER			1	1	1	1	
56129890	4750980180	JUNTA DO TUBO DO COLETOR DE ADMISSÃO DE AR			1	1	1	1	
56130290	4750880280	JUNTA DO TUBO DO COLETOR DE ADMISSÃO DE AR			1	1	1	1	
56130390	4422010480	JUNTA DA BOMBA DE ÁGUA			1	1	1	1	
56130616	3504920080	JUNTA DA SAÍDA ESCAPAMENTO			1	1	1	1	
56132490	4031840280	JUNTA DO CABEÇOTE DO FILTRO DE ÓLEO			1	1	1	1	
56132590	4032011080	JUNTA DA BOMBA DE ÁGUA			1	1	1	1	
56132690	917003040003	JUNTA DA FLANGE DA CONEXÃO DE AQUECIMENTO			1	1	1	1	
56132795	917003036002	JUNTA DA PENEIRA DA BOMBA DE ÓLEO			1	1	1	1	
56132950	4750150180	JUNTA DA TAMPA DE INSPEÇÃO			1	1	1	1	
56141095	4031310780	JUNTA INFERIOR DA CARÇAÇA DO COMPRESSOR DE AR			1	1	1	1	
56142490	917003026000	JUNTA DA REFRIGERAÇÃO DO ÓLEO DO CABEÇOTE			2	2	2	2	
56145416	4071310780	JUNTA DA VÁLVULA DO CABEÇOTE DO COMPRESSOR DE AR			1	1	1	1	
56164640	39975750	PLUG DO BICO INJETOR	1	1	5	5	6	6	
56167940		ANEL CAMISA 144X3,8MM	2	2	10	10	12	12	
59651490	4071310880	JUNTA DO CABEÇOTE DO COMPRESSOR DE AR			1	1	1	1	
60086110		KIT DE ARRUELAS			1	1	1	1	
86149032		KIT DOS ANÉIS DAS CAMISAS			5	5	6	6	

• VENDE-SE AVULSO

APLICAÇÃO



MERCEDES CAMINHÃO OM 449A/449LA 5 CIL - 1630 1990/99 ; 1632 1999/02 ; 1625 1989/96 ; 2225 1987/90 ; 2325 1989/00
 MERCEDES CAMINHÃO OM 447A/447LA 6 CIL - 1634 2001/05 ; 1934 1984/91 ; 2635 1992/99 ; 1941 1989/97 ; 1935 1989/99 ; 2638/2038 1996/98
 MERCEDES ÔNIBUS OM 449A/449LA 5 CIL - O 371 R 1992/97 ; O 371 UP 1990/97 ; O 400 R 1994/97 ; O 400 UP 1995/97 ; O 400 UPA 1995/98 OH 1625/OH 1630 1990/95 ; OH 1628 1998/04
 MERCEDES ÔNIBUS OM 447A/447LA 6 CIL - O 371 RS/O 371 RSD 1990/98 ; O400 RSL/RSD 1994/99 ; O400 RS 1994/03 ; O 400 RSE/O 371 RSE 1997/99 ; OH 1625/OH 1636 1994/95

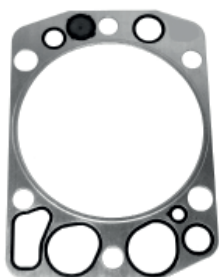

56137200

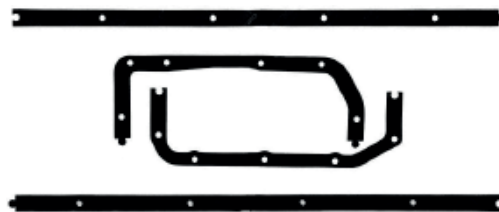

56151067

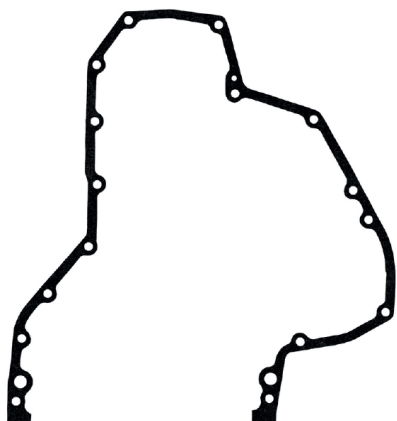

56142398



56151167



56132298

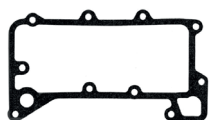

56132490



56129890



56130490



59651490



56130616



56139239



56130290



56141317



56132950



56132795



56128690



56132690



56142490



54308490



54308398



56128690



56141095



56145416



56132590



56164640



56130390



50014123

86149032		KIT DE ANÉIS DE CAMISA	
Nº ABR	DESCRIÇÃO	QTD	
56141119	ANEL TOMBAK 147,3X153,3X0,15MM	1	
56167840	VEDADOR DE BORRACHA 140,0 X 1,8 MM	1	
56167940	VEDADOR DE BORRACHA 144,0 X 3,8 MM	2	

60086116		KIT DE ARRUELAS	
Nº ABR	DESCRIÇÃO	QTD	
50023729	ARRUELA DE ALUMÍNIO 16,3 X 21,6 X 1,5MM	1	
50021429	ARRUELA DE ALUMÍNIO 14,2X18,0X1,50MM	4	
50032729	ARRUELA DE COBRE 18,3 X 22,2 X 1,50MM	1	
50023624	ARRUELA DE COBRE 16,3 X 19,8 X 1,50MM	2	
50072424	ARRUELA DE COBRE 22,5 X 26,7 X 1,50MM	1	
50029520	ARRUELA DE COBRE 24,2 X 29,4 X 2,0MM	1	
50030720	ARRUELA DE COBRE 26,3 X 30,9 X 2,00MM	1	
50014123	ARRUELA DE COBRE 9,5 X 20,0 X 1,0MM	6	

MERCEDES OM 457LA 6 CILINDROS / 12L 24V ATÉ MOTOR 32558 (CABEÇOTE SEM REBAIXO) EURO 3

Nº JOGO		DESCRIÇÃO						
66114611	JOGO DE JUNTAS COMPLETO OM 457LA 6 CILINDROS ATÉ MOTOR 32558 SEM ANÉIS DE CAMISAS SEM RETENTORES		1					
76114611	JOGO DE JUNTAS COMPLETO OM 457LA 6 CILINDROS ATÉ MOTOR 32558 SEM ANÉIS DE CAMISAS COM RETENTORES		2					
76114619	JOGO DE JUNTAS COMPLETO OM 457LA 6 CILINDROS ATÉ MOTOR 32558 COM ANÉIS DE CAMISAS COM RETENTORES		3					
66134611	JOGO DE JUNTAS MONOCILÍNDRICO OM 457LA 6 CILINDROS ATÉ MOTOR 32558 SEM ANÉIS DE CAMISAS SEM RETENTORES		4					
76134611	JOGO DE JUNTAS MONOCILÍNDRICO OM 457LA 6 CILINDROS ATÉ MOTOR 32558 SEM ANÉIS DE CAMISAS COM RETENTORES		5					
76134619	JOGO DE JUNTAS MONOCILÍNDRICO OM 457LA 6 CILINDROS ATÉ MOTOR 32558 COM ANÉIS DE CAMISAS COM RETENTORES		6					
Nº ABR	Nº ORIGINAL	DESCRIÇÃO						
56169405	4570161120	JUNTA DO CABEÇOTE OM 457 6 CILINDROS	1	1	1	6	6	6
56164967	4570160021	JUNTA DA TAMPADA DAS VÁLVULAS (ALUMÍNIO)	1	1	1	6	6	6
56165940	A4570160221	JUNTA DA TAMPADA DAS VÁLVULAS (PLÁSTICA)	1	1	1	6	6	6
56165716	4571410080	JUNTA DO COLETOR DE ADMISSÃO (HTM-P)	1	1	1	6	6	6
56169767		JUNTA DO CÂRTER (OM457 6 CILINDROS - SECCIONADA)				1	1	1
56151167	4070140222	JUNTA DO CÂRTER (OM457 6 CILINDROS - SECCIONADA)				1	1	1
56142377	4290150080	JUNTA DA TAMPADA DA DISTRIBUIÇÃO				1	1	1
56165167	4030110080	JUNTA DA TAMPADA DIANTEIRA DO BLOCO				1	1	1
RE02697F		RETENTOR TRASEIRO DO VIRABREQUIM				1	1	
RE02696F		RETENTOR DIANTEIRO DO VIRABREQUIM				1	1	
RE09237F		RETENTOR DA HASTE DAS VÁLVULAS	2	2		12	12	
50011024		ARRUELA DE COBRE 7,3 X 15,3 X 2,0 MM	1	1	1			
56130390	4422010480	JUNTA DO TUBO DA BOMBA DE ÁGUA				1	1	1
56132490	4031840280	JUNTA DO CABEÇOTE DO FILTRO DE ÓLEO				1	1	1
56132950	4750150180	JUNTA DA TAMPADA DE INSPEÇÃO				1	1	1
56139239	4031420380	JUNTA DO COLETOR DE ESCAPAMENTO	1	1	1	6	6	6
56141119	4420110059	CALÇO DE CAMISA 146,18 X 155,00 X 0,15MM	1	1	1	6	6	6
56142490	917003026000	JUNTA DA REFRIGERAÇÃO DO ÓLEO DO CABEÇOTE				2	2	2
56164590	A4572010080	JUNTA DA BOMBA DE ÁGUA				1	1	1
56165367	4602010080	JUNTA DA FLANGE DO ENCHIMENTO DE ÓLEO				1	1	1
56165431	4570910180	JUNTA DO ACOPLAMENTO DA BOMBA INJETORA				1	1	1
56165567	623208520044	JUNTA DA SAÍDA DO ÓLEO				1	1	1
56165667	4421870080	JUNTA DA ENTRADA DO ÓLEO				1	1	1
56166040		ANEL DE CAMISA 144.5 X 159.1 X 7,0 MM	2					
86151140		KIT DOS ANÉIS DE BORRACHA (COM ANÉIS DE CAMISA)				1		
86151240		KIT DOS ANÉIS DE BORRACHA (SEM ANÉIS DE CAMISA)					1	1
86151329		KIT DE ARRUELAS				1	1	1

• VENDE-SE AVULSO

APLICAÇÃO

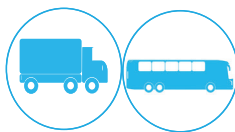

MERCEDES CAMINHÃO AXOR 1938/2638 1998/06 ; 1944 2002/05

MERCEDES ÔNIBUS O400 RSD 1998/04 ; O 400 RSE 1998/02

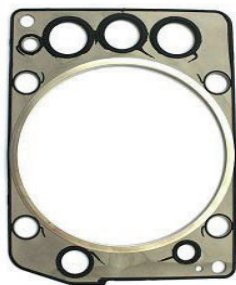

56169405

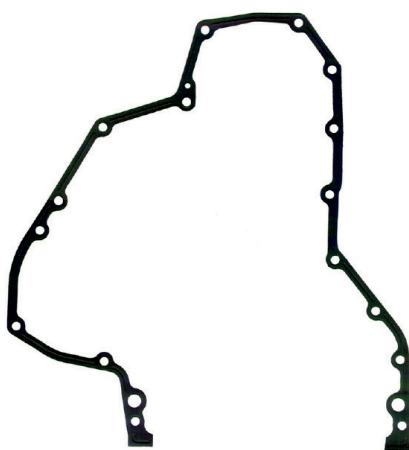

56142377



56164509



56151167

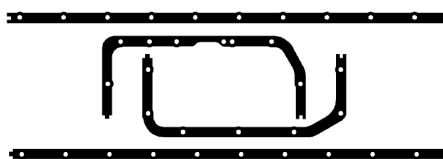

56169767

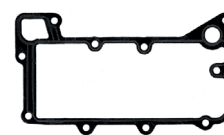

56132490



56165367



56165431



56139239



56165716



56130390



56142490



56165667



56165567



56164967



56165940



56166040



56141119



RE02696F



RE02697F



50011024



RE09237F



56165167

86151140 KIT BORRACHA OM 457		
Nº ABR	DESCRIÇÃO	QTD
56166040	ANEL DE CAMISA 144,5X159,1X7,0MM	12
50037341	VEDADOR 15,0 X 2,5MM	1
50011741	VEDADOR 57,0 X 3,5MM	1
54388340	VEDADOR 82,15 X 3,5MM	1
	VEDADOR 79,85 X 3,0MM	2

86151240 KIT DOS ANÉIS DE BORRACHA SEM ANÉIS DE CAMISA		
Nº ABR	DESCRIÇÃO	QTD
50037341	VEDADOR 15,0 X 2,5MM	1
50011741	VEDADOR 57,0 X 3,5MM	1
54388340	VEDADOR 82,15 X 3,5MM	1
	VEDADOR 79,85 X 3,0MM	2

86151329 KIT DE ARRUELAS OM 457			
Nº ABR	DESCRIÇÃO		QTD
50023624	ARRUELA DE COBRE 16,3 X 19,8 X 1,50MM		2
50072424	ARRUELA DE COBRE 22,5 X 26,7 X 1,50MM		1
50030420	ARRUELA DE COBRE 26,0 X 32,0 X 2,00MM		1
	ARRUELA DE COBRE 26,3 X 31,7 X 3,00MM		1
50022224	ARRUELA DE COBRE 14,6 X 20,8 X 1,50MM		3
50022229	ARRUELA DE ALUMÍNIO 14,6 X 20,8 X 1,5MM		1
50029720	ARRUELA DE COBRE 24,5 X 28,8 X 2,00MM		2
50011023	ARRUELA DE COBRE 7,2 X 15,2 X 1,50MM		6

Nº JOGO	DESCRIÇÃO	
66114631	JOGO DE JUNTAS COMPLETO OM 457LA 6 CILINDROS APÓS MOTOR 32559 SEM ANÉIS DE CAMISAS SEM RETENTORES	1
76114631	JOGO DE JUNTAS COMPLETO OM 457LA 6 CILINDROS APÓS MOTOR 32559 SEM ANÉIS DE CAMISAS COM RETENTORES	2
76114639	JOGO DE JUNTAS COMPLETO OM 457LA 6 CILINDROS APÓS MOTOR 32559 COM ANÉIS DE CAMISAS COM RETENTORES	3
76134599	JOGO DE JUNTAS MONOCILÍNDRICO OM 457LA 6 CILINDROS APÓS MOTOR 32559 COM ANÉIS DE CAMISAS COM RETENTORES	4
76134609	JOGO DE JUNTAS MONOCILÍNDRICO OM 457LA 6 CILINDROS APÓS MOTOR 32559 COM ANÉIS DE CAMISAS COM RETENTORES	5

Nº ABR	Nº ORIGINAL	DESCRIÇÃO				
56165005	4570161220	JUNTA DO CABEÇOTE OM 457 6 CILINDROS	1	1	6	6 6
56164967	4570160021	JUNTA DA TAMPA DAS VÁLVULAS (ALUMÍNIO)	1	1	6	6 6
56165940	4570160221	JUNTA DA TAMPA DAS VÁLVULAS (PLÁSTICA)		1	6	6 6
56139239	4031420380	JUNTA DO COLETOR DE ESCAPAMENTO	1		6	6 6
56168030	5411420380	JUNTA DO COLETOR DE ESCAPAMENTO		1	6	6 6
56160530	4570980180	JUNTA DO COLETOR DE ADMISSÃO	1	1	6	6 6
56165716	4571410080	JUNTA DO COLETOR DE ADMISSÃO	1	1	6	6 6
56169767	4570140122	JUNTA DO CÂRTER (OM457 6 CILINDROS - SECCIONADA)			1	1 1
56142377	4290150080	JUNTA DA TAMPA DA DISTRIBUIÇÃO			1	1 1
56165167	5410110080	JUNTA DA TAMPA DIANTEIRA DO BLOCO			1	1 1
56178767	4570110880	JUNTA DA TAMPA DIANTEIRA DO BLOCO			1	1 1
56179067	4600110180	JUNTA DA TAMPA DIANTEIRA DO BLOCO			1	1 1
RE05155T		RETENTOR TRASEIRO DO VIRABREQUIM			1	1
RE05184T		RETENTOR DIANTEIRO DO VIRABREQUIM			1	1
RE09237F		RETENTOR DA HASTE DAS VÁLVULAS	4	4	24	24
50011024		ARRUELA DE COBRE 7,3 X 15,3 X 2,0 MM	1	1		
56130390	4222010480	JUNTA DO TUBO DA BOMBA DE ÁGUA	1	1	1	1 1
56132490	4031840280	JUNTA DO CABEÇOTE DO FILTRO DE ÓLEO			1	1 1
56132950	475.015.01.80	JUNTA DA TAMPA DE INSPEÇÃO			1	1 1
56141119	4570110259	CALÇO DE CAMISA 146,18 X 155,00 X 0,15MM	1	1	6	6 6
56142490	9170030260	JUNTA DA REFRIGERAÇÃO DO ÓLEO DO CABEÇOTE			1	1 1
56164590	4572010080	JUNTA DA BOMBA DE ÁGUA			1	1 1
56165367	460.201.0080	JUNTA DA FLANGE DO ENCHIMENTO DE ÓLEO			1	1 1
56165431	4570810180	JUNTA DO ACOPLAMENTO DA BOMBA INJETORA				
56165567	6171870180	JUNTA DA SAÍDA DO ÓLEO			1	1 1
56165667	4421870080	JUNTA DA ENTRADA DO ÓLEO			1	1 1
56166040	4579970545	ANEL DE CAMISA 144,5 X 159,1 X 7,0 MM	2	2		
56174231	000160040	VEDADOR DA TAMPA DE VÁLVULAS			12	12 12
56178867	4570980880	JUNTA DO TUBO DE ADMISSÃO			1	1 1
56180067	4571880280	JUNTA DO CABEÇOTE DO FILTRO DE ÓLEO			1	1 1
56180850	A4570150080	JUNTA TUBO RESPIRO 457 LA EURO 5			1	1 1
86151140		KIT DOS ANÉIS DE BORRACHA (COM ANÉIS DE CAMISA)			1	
86151240		KIT DOS ANÉIS DE BORRACHA (SEM ANÉIS DE CAMISA)				1 1
86153029		KIT DE ARRUELAS			1	1 1

● VENDE-SE AVULSO

APLICAÇÃO



MERCEDES CAMINHÃO AXOR 1634/2640/4144 2006/12 ; 2035/2040/2044/2544/2644/3344 2005/12 ; 2535 2009/13 ; 2036 2011/... 2041/2541 2011/...2536 2012/... 2540 2004/12 ; 3340 2005/11 ; 4140 2005/11 ; 2641/3341/4141 2012/16 ; 2544/2644 2013/... 3344/4144 2013/...ATRON 1635 2012/...
 MERCEDES ÔNIBUS O 500 MA/O 500 UA/O 500 RS/O 500 RSD 2006/12 ; O 500 RSD/UDA/MDA 2013/...

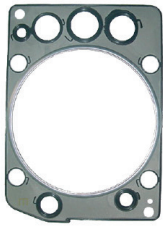

56165005



56169767

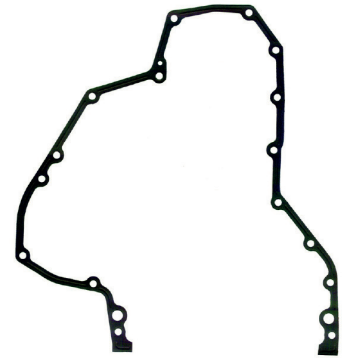

56142377



56164590



56139239



56165716



56168030



56165367



56132950



56130390



56165667



56142490



56165567



56160530



56180850



56165940



56164967



56178867

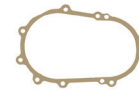

56178767



56166040

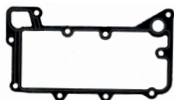

56132490

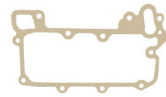

56180067



56165167



56179067

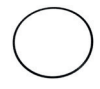

56141119



RE05184T



RE05155T



56174231



50011024



RE09237F

86151140		KIT BORRACHA OM 457	
Nº ABR	DESCRIÇÃO	QTD	
56166040	ANEL DE CAMISA 144,5X159,1X7,0MM	12	
50037341	VEDADOR 15,0 X 2,5 MM	1	
50011741	VEDADOR 57,0 X 3,5 MM	1	
54388340	VEDADOR 82,15 X 3,5 MM	1	
	VEDADOR 79,85 X 3,0 MM	2	

86151240		KIT DOS ANÉIS DE BORRACHA SEM ANÉIS DE CAMISA	
Nº ABR	DESCRIÇÃO	QTD	
50037341	VEDADOR 15,0 X 2,5 MM	1	
50011741	VEDADOR 57,0 X 3,5 MM	1	
54388340	VEDADOR 82,15 X 3,5 MM	1	
	VEDADOR 79,85 X 3,0 MM	2	

86153029		KIT DE ARRUELAS OM 457	
Nº ABR	DESCRIÇÃO	QTD	
50023624	ARRUELA DE ALUMÍNIO 16,20 X 20,00 X 1,50MM	2	
50022224	ARRUELA DE ALUMÍNIO 14,30 X 18,30 X 1,50MM	21	
50072424	ARRUELA DE ALUMÍNIO 22,30 X 26,80 X 1,50MM	1	
	ARRUELA DE ALUMÍNIO 16,20 X 22,30 X 1,50MM	20	
	ARRUELA DE ALUMÍNIO 12,10 X 16,20 X 1,50MM	12	
	ARRUELA DE ALUMÍNIO 8,20 X 12,10 X 1,00MM	30	
50011024	ARRUELA DE COBRE 7,40 X 15,00 X 1,50MM	6	
	ARRUELA DE ALUMÍNIO 26,60 X 31,50 X 2,00MM	3	
	ARRUELA DE ALUMÍNIO 24,30 X 30,30 X 1,50MM	2	

MERCEDES OM 611 4 CILINDROS 2.2L 16V ELETRÔNICO (EURO 3)

Nº JOGO		DESCRIÇÃO		
76114651		JOGO DE JUNTAS COMPLETO MERCEDES OM 611 SPRINTER 413 CDI 2.2 16V 98/ COM RETENTORES	1	
76134651		JOGO DE JUNTAS SUPERIOR MERCEDES OM 611 SPRINTER 413 CDI 2.2 16V 98/ COM RETENTORES	2	
Nº ABR	Nº ORIGINAL	DESCRIÇÃO		
56175302	6110161120	JUNTA DE CABEÇOTE	1	1
56175040	6110160121	JUNTA DA TAMPA DE VÁLVULA	1	1
56175231	6111420780	JUNTA DO COLETOR DE ESCAPE	1	1
56175131	6420140022	JUNTA DO CÁRTER		1
56175440	6110980380	JUNTA DO COLETOR DE ADMSSÃO	4	4
RE07795T	0219977647	RETENTOR DIANTEIRO		1
RE05813S	611010214	RETENTOR TRASEIRO		1
RE07927F		RETENTOR DA HASTE VÁLVULA	16	16
56174930	6112010280	JUNTA DA BOMBA DE ÁGUA		1
56176540	6112030380	JUNTA DO VEDADOR DA BOMBA DE ÁGUA	1	1
50011923		ARRUELA	4	
86152426		KIT DE ARRUELAS	1	1
86152526		KIT DE BORRACHAS		1

• VENDE-SE AVULSO

APLICAÇÃO



MERCEDES VANS SPRINTER 311/313/413 CDI 2005/12 2005/12 ; 2535 2009/13 ; 2036 2011/...

MERCEDES OM 611 4 CILINDROS 2.2L 16V ELETRÔNICO (EURO 3)



56175302

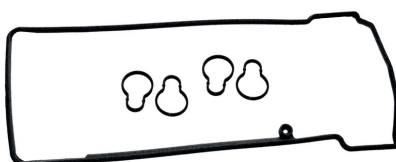

56175040

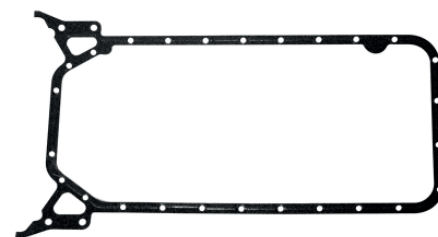

56175131



56175231

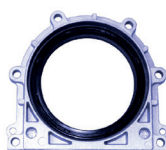

RE05813S



56176767



56176540



56175440



RE07795T



RE07927F

86151140 KIT BORRACHA OM 457		
Nº ABR	DESCRIÇÃO	QTD
56166040	ANEL DE CAMISA 144,5 X 159,1 X 7,0MM	12
50037341	VEDADOR 15,0 X 2,5 MM	1
50011741	VEDADOR 57,0 X 3,5 MM	1
54388340	VEDADOR 82,15 X 3,5 MM	1
	VEDADOR 79,85 X 3,0 MM	2

86152425 KIT BORRACHA OM 457		
Nº ORIGINAL	DESCRIÇÃO	QTD
0189971948	VEDADOR 26,5 X 2,1MM	1
1110180080	VEDADOR 47,5 X 59,0 X 2,3 MM	1
0069977548	VEDADOR 36,5 X 2,0MM	1
0069977648	VEDADOR 12,0 X 2,0MM	1
1049970048	VEDADOR 10,0 X 2,0MM	1
0229978048	VEDADOR 8,6 X 2,5MM	1
6112030380	VEDADOR DA BOMBA DE ÁGUA	1
6111840280	VEDADOR DO FILTRO ÓLEO	1
6110980380	VEDADOR DO COLETOR DE ADMISSÃO	4

MERCEDES OM 904/924 4 CILINDROS 4.25/4.8L ELETRÔNICO(EURO3/5)

Nº JOGO	Nº ORIGINAL	DESCRIÇÃO
76119041		JOGO DE JUNTAS COMPLETO OM 904 PARA TAMPA DE VÁLVULAS DE PLÁSTICO COM RETENTORES
66119041		JOGO DE JUNTAS COMPLETO OM 904 PARA TAMPA DE VÁLVULAS DE PLÁSTICO SEM RETENTORES
76119241		JOGO DE JUNTAS COMPLETO OM 924 PARA TAMPA DE VÁLVULAS DE PLÁSTICO COM RETENTORES
66119241		JOGO DE JUNTAS COMPLETO OM 924 PARA TAMPA DE VÁLVULAS DE PLÁSTICO SEM RETENTORES
76139041	9040101921	JOGO DE JUNTAS SUPERIOR OM 904 PARA TAMPA DE VÁLVULAS DE PLÁSTICO COM RETENTORES
76139241	9240101520	JOGO DE JUNTAS SUPERIOR OM 924 PARA TAMPA DE VÁLVULAS DE PLÁSTICO COM RETENTORES

Nº ABR	Nº ORIGINAL	DESCRIÇÃO	1	2	3	4	5	6
56182005	9040161320	JUNTA DO CABEÇOTE OM 904 Ø103,7MM (NOVA)		1				1
56182205	924 0161120	JUNTA DO CABEÇOTE OM 924 Ø107,7MM (NOVA)	1		1	1		
56173340	0000160421	JUNTA DA TAMPA DAS VÁLVULAS (PARA TAMPA DE PLÁSTICO)	1	1	1	1	1	1
56173540	9040160721	JUNTA LATERAL DA TAMPA DAS VÁLVULAS (PARA TAMPA DE PLÁSTICO)	1	1	1	1	1	1
56175030	9061420280	JUNTA DO COLETOR DE ESCAPAMENTO	2	2	2	2	2	2
56174431	9061410180	JUNTA DO COLETOR DE ADMISSÃO	2	2	2	2	2	2
56174667	9040140622	JUNTA DO CÁRTER			1	1	1	1
RE05155T	0219975347	RETENTOR TRASEIRO DO VIRABREQUIM					1	1
RE05214T	0229977647	RETENTOR DIANTEIRO DO VIRABREQUIM					1	1
RE09284F	9060530358	RETENTOR DA HASTE DE VÁLVULA	12	12	12	12	12	12
56173831	9062030180	JUNTA DO TUBO DE REFRIGERAÇÃO	1	1	1	1	1	1
56174231	0000160040	ISOLADOR DE RUÍDO	5	5	5	5	5	5
56174367	9062010080	JUNTA DA BOMBA DE ÁGUA			1	1	1	1
56174867	9041880280	JUNTA DO RADIADOR DE ÓLEO			1	1	1	1
56174931	9060910380	JUNTA DA BOMBA DE COMBUSTÍVEL	1	1	1	1	1	1
56175840	0001883280	JUNTA RESFRIADOR DE ÓLEO	1	1	1	1	1	1
56179140	9041410280	JUNTA DO COLETOR DE ADMISSÃO	4	4	4	4	4	4
56184140		JUNTA DA TA TAMPA DE VÁLVULAS						
86173340		KIT DA TAMPA DAS VÁLVULAS (PARA TAMPA DE PLÁSTICO) COM VEDADORES						
86151626		KIT DE ARRUELAS	1	1	1	1	1	1
86152046		KIT DOS ANÉIS DE BORRACHA	1	1	1	1	1	1

• VENDE-SE AVULSO

APLICAÇÃO

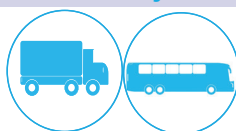

MERCEDES CAMINHÃO OM924 (COM TAMPA DE VÁLVULAS DE PLÁSTICO) 1622 2001/05 ; ACCELO 815/1016 2011/...ACCELO 1316 2015/...
ATEGO 1419 2012/...ATEGO 1719 2011/... / ATRON 1319 2012/16 ; ATRON 1719 2013/16
MERCEDES ÔNIBUS OM924 (COM TAMPA DE VÁLVULAS DE PLÁSTICO) OH 1521 1999/02 ; OH 1622L 2007/12 ; OF 1722 2001/11 ; OF 1722M 2003/12 ; OF 1721/OF 1721L 2004/... OH 1621L 2013/...VOLARE ÔNIBUS W9 FLY/DW9 FLY 2012/14
MERCEDES CAMINHÃO OM904 (MERCEDES CAMINHÃO OM904 COM TAMPA DE VÁLVULAS DE PLÁSTICO) 1215C 1999/04 ; 914C 1999/03 ; 1718 2000/12 ; 1318 2003/12 ; 1218 2001/04 ; 1418 2001/03 ATEGO 1418 2004/12 ; ATEGO 1315 2005/10 ; ATEGO 1518/1718 2005/12 ; ACCELO 915C 2002/12
MERCEDES ÔNIBUS OM904 (MERCEDES CAMINHÃO OM904 COM TAMPA DE VÁLVULAS DE PLÁSTICO) ATILIS 712E 2006/09 ;
LO 914 1999/04 ; LO 915 2003/12 ; OF 1218 2007/11 ; OF 1417 2001/06 ; OF 1418 2003/11 OH 1417 1998/05 ; OH 1418 2003/07 ; OH 1518 2006/12 ; OH 1519 2013/...

MERCEDES OM 904/924 4 CILINDROS 4.25/4.8L ELETRÔNICO(EURO3/5)

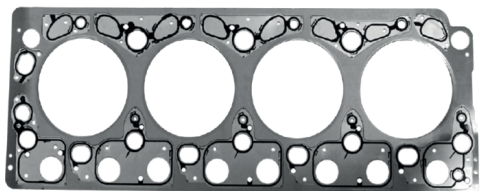

56182005 - DIÂMETRO 103,7 MM

56182205 - DIÂMETRO 107,7 MM

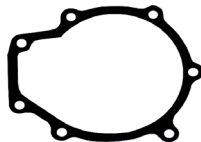

56174367

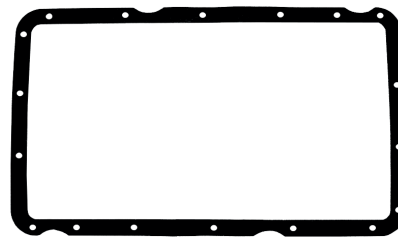

56174667

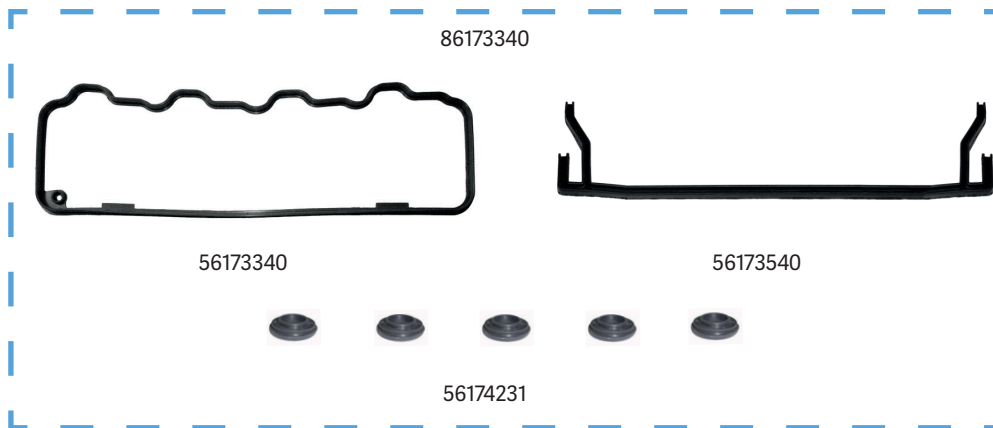

86173340

56173340

56173540

56174231

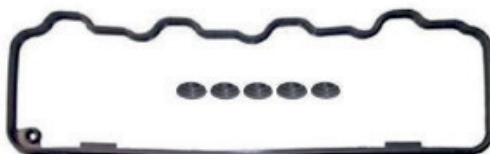

56184140



56175640



56174431



56175030

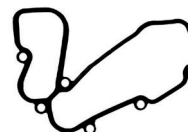

56175840



56174931



56173831



56179140



56174867



RE05155T



RE05214T



RE09284F

86151626 KIT DE ARRUELA OM 904		
Nº ABR	DESCRIÇÃO	QTD
50030420	ARRUELA DE COBRE 26,0X32,0X2,0MM	1
50027329	ARRUELA DE COBRE 20,0X26,0X1,5MM	2
50069229	ARRUELA DE COBRE 18,0X22,0X1,5MM	1
50025424	ARRUELA DE COBRE 18,0X24,0X1,5MM	1
50021524	ARRUELA DE COBRE 14,3X19,8X1,5MM	1
50021229	ARRUELA DE COBRE 14,0X20,0X1,5MM	1
50011023	ARRUELA DE COBRE 7,2X15,2X1,5MM	4

86152046 KIT DE BORRACHA OM 904			
Nº ABR	DESCRIÇÃO	QTD	
0279978348	VEDADOR 37,8X2,62MM	8	
0239976848	VEDADOR 9,0X2,5 MM	4	
5419970745	VEDADOR 25,0X3,7 MM	4	
5419970545	VEDADOR 20,9X3,0 MM	4	
5419970645	VEDADOR 11,0X3,0 MM	4	
0209971148	VEDADOR 60,0X4,2 MM	2	
0249972148	VEDADOR 118,0X3,0 MM	1	
0020941580	VEDADOR	1	
9061840280	VEDADOR DO FILTRO DE ÓLEO	1	

MERCEDES OM 906/926 6.4/7.2L ELETRÔNICO(EURO3/5)

Nº JOGO	Nº ORIGINAL	DESCRIÇÃO
76119061		JOGO DE JUNTAS COMPLETO OM 906 PARA TAMPA DE VÁLVULAS DE PLÁSTICO COM RETENTORES 1
66119061		JOGO DE JUNTAS COMPLETO OM 906 PARA TAMPA DE VÁLVULAS DE PLÁSTICO SEM RETENTORES 2
76119261		JOGO DE JUNTAS COMPLETO OM 926 PARA TAMPA DE VÁLVULAS DE PLÁSTICO COM RETENTORES 3
66119261		JOGO DE JUNTAS COMPLETO OM 926 PARA TAMPA DE VÁLVULAS DE PLÁSTICO SEM RETENTORES 4
76139061	9040101921	JOGO DE JUNTAS SUPERIOR OM 906 PARA TAMPA DE VÁLVULAS DE PLÁSTICO COM RETENTORES 5
76139261	9240101520	JOGO DE JUNTAS SUPERIOR OM 926 PARA TAMPA DE VÁLVULAS DE PLÁSTICO COM RETENTORES 6

Nº ABR	Nº ORIGINAL	DESCRIÇÃO					
56182105	9060161420	JUNTA DO CABEÇOTE OM 906 Ø103,7MM (NOVA)		1			1 1
56182305	9260161220	JUNTA DO CABEÇOTE OM 926 Ø107,7MM (NOVA)	1		1	1	
56173440	0000160521	JUNTA DA TAMPA DAS VÁLVULAS (PARA TAMPA DE PLÁSTICO)	1	1	1	1	1 1
56184040		JUNTA DA TAMPA DAS VÁLVULAS (PARA TAMPA DE PLÁSTICO) COM VENDADORES					
56173640	9060160721	JUNTA LATERAL DA TAMPA DAS VÁLVULAS (PARA TAMPA DE PLÁSTICO)	1	1	1	1	1 1
56175030	9061420280	JUNTA DO COLETOR DE ESCAPAMENTO	3	3	3	3	3 3
56174431	9061410180	JUNTA DO COLETOR DE ADMISSÃO	3	3	3	3	3 3
56174767	9060140522	JUNTA DO CÁRTER			1	1	1 1
RE05155T	219975347	RETENTOR TRASEIRO DO VIRABREQUIM				1	1
RE05214T	229977647	RETENTOR DIANTEIRO DO VIRABREQUIM				1	1
RE09284F	9060530358	RETENTOR DA HASTE DAS VÁLVULAS	18	18	18	18	18 18
56173831	9062030180	JUNTA DO TUBO DE REFRIGERAÇÃO	1	1	1	1	1 1
56174231	0000160040	ISOLADOR DE RUÍDO	7	7	7	7	7 7
56174367	9062010080	JUNTA DA BOMBA DE ÁGUA			1	1	1 1
56174567	9061880280	JUNTA DO RADIADOR DE ÓLEO			1	1	1 1
56174931	9060910380	JUNTA DA BOMBA DE COMBUSTÍVEL	1	1	1	1	1 1
56175740	1883380	JUNTA RESFRIADOR DE ÓLEO	1	1	1	1	1 1
56179140	9041410280	JUNTA DO COLETOR DE ADMISSÃO	6	6	6	6	6 6
86173440		KIT DA TAMPA DAS VÁLVULAS (PARA TAMPA DE PLÁSTICO)					
86151826		KIT DE ARRUELAS	1	1	1	1	1 1
86152146		KIT DOS ANÉIS DE BORRACHA	1	1	1	1	1 1

• VENDE-SE AVULSO

APLICAÇÃO



MERCEDES CAMINHÃO OM926 (COM TAMPA DE VÁLVULAS DE PLÁSTICO) 1728 2003/06 ; 2428 2001/06 ; ATEGO 1726/1729 2013/ ATEGO 1728/2428 2007/12 ; ATEGO 2426 2011/ ATEGO 2429 2012/15 ;
ATEGO 2430 2014/ATEGO 1730/2730/3026/3030 2016/ATRON 2324/2729 2011/16 ; AXOR 1933/2533 2005/AXOR 2831 2012/15 ; AXOR 3131 2013/
MERCEDES ÔNIBUS OM926 (COM TAMPA DE VÁLVULAS DE PLÁSTICO) O 500 M 2001/2011 ; O 500 R 2005/11 ; OF 1730 2010/12
MERCEDES CAMINHÃO OM906 (COM TAMPA DE VÁLVULAS DE PLÁSTICO) 2423 1999/09 ; 2726 2008/12 ; 1620 2006/12 ; ATEGO 1725 2009/12 ; ATEGO 2425 2005/12 ; AXOR 2826 2006/11 ;
MERCEDES ÔNIBUS OM906 (COM TAMPA DE VÁLVULAS DE PLÁSTICO) O 500 U 2013/...OH 1635 1995/99

MERCEDES OM 906/926 6.4/7.2L ELETRÔNICO(EURO3/5)

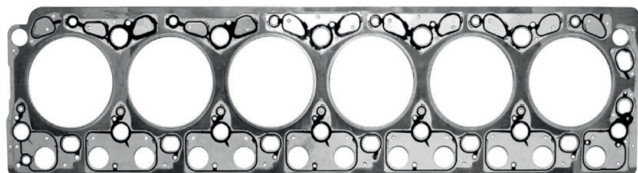

56182105 - DIÂMETRO 103,7 MM

56182305 - DIÂMETRO 107,7 MM

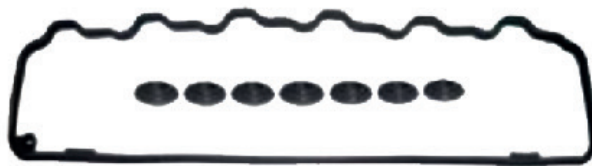

56184040

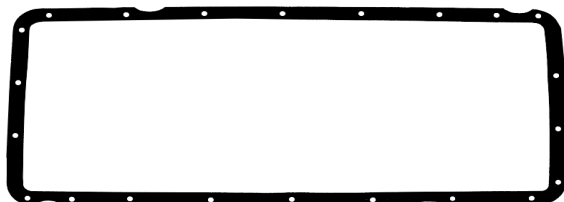

56174767

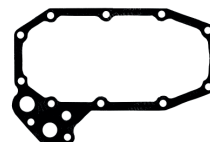

56174567

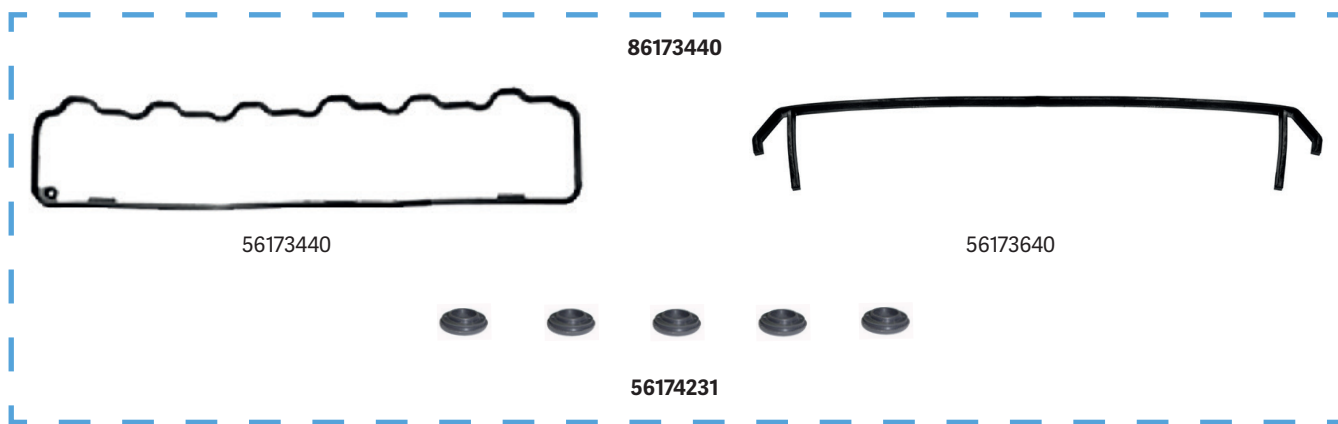

86173440

56173440

56173640

56174231

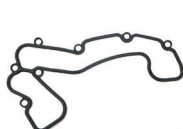

56175740



56175640



56174367



56174431



56175030



56174931



56173831



56179140



RE09284F



RE05214T



RE05155T



56174231

86151826		KIT DE ARRUELA OM 904	
Nº ABR	DESCRIÇÃO		QTD
50030420	ARRUELA DE COBRE 26,0X32,0X2,0MM		1
50027329	ARRUELA DE COBRE 20,0X26,0X1,5MM		2
50069229	ARRUELA DE ALUMÍNIO 18,0X22,0X1,5MM		1
50021524	ARRUELA DE COBRE 14,3X19,8X1,5MM		1
50023624	ARRUELA DE COBRE 16,3X19,8X1,5 MM		1
50021229	ARRUELA DE ALUMÍNIO 14,0X20,0X1,5 MM		1
50011023	ARRUELA DE OBRE 7,2X15,2X1,5 MM		6

86152146		KIT DE ARRUELA OM 904	
Nº ABR	DESCRIÇÃO		QTD
0279978348	VEDADOR 37,8X2,62MM		8
0239976848	VEDADOR 9,0X2,5MM		6
5419970745	VEDADOR 25,0X3,7MM		6
5419970545	VEDADOR 20,9X3,0MM		6
5419970645	VEDADOR 11,0X3,0MM		6
0209971148	VEDADOR 60,0X4,2MM		2
0249972148	VEDADOR 118,0X3,0MM		1
0020941580	VEDADOR		1
9061840280	VEDADOR DO FILTRO DO ÓLEO		1

MERCEDES OM 612 2.7L 20V ELETRÔNICO(EURO3)

Nº JOGO		DESCRIÇÃO			
76114682		JOGO DE JUNTAS COMPLETO MERCEDES OM 612 COM RETENTORES INCLUSIVE FLANGE TRASEIRO		1	
76134682		JOGO DE JUNTAS SUPERIOR MERCEDES OM 612 COM RETENTORES SEM FLANGE TRASEIRO		2	
Nº ABR	Nº ORIGINAL	DESCRIÇÃO			
56176002	6470161420	JUNTA DO CABEÇOTE		1	1
56176140	6120160021	JUNTA DA TAMPA DE VÁLVULA		1	1
56176230	6121410180	JUNTA DO COLETOR ADMISSÃO		1	1
56176330	6121450380	JUNTA DO COLETOR DE ESCAPE		1	1
56176430	6120140122	JUNTA DE CÁRTER			1
RE05813S	6110100214	RETETOR TRASEIRO			1
RE07795T	0219977647	RETENTOR DIANTEIRO			1
RE07927F	0000534158	RETENTOR DA HASTE DE VÁLVULA		20	20
56176630		JUNTA DO RESFRIADOR DE ÓLEO			1
56176830		JUNTA DA ENTRADA DE ÓLEO			1
56176540	6111840280	JUNTA DO FILTRO DE ÓLEO			1
56176730	6112010280	JUNTA DA BOMBA DE ÁGUA			1
86152640		KIT DE BORRACHAS		1	1
56177040	6110940080	JUNTA DE ADMISSÃO		5	5
56177140		JUNTA DO RESFRIADOR DO ÓLEO			1

• VENDE-SE AVULSO

APLICAÇÃO



MOTOR MERCEDES OM 612 5 CILINDROS 2.7L 20V ELETRÔNICO(EURO 3)

MERCEDES CAMINHÃO ACCELO 715C DI 2002/11 ; JEEP GRAN CHEROKEE II 2001/05

MERCEDES OM 612 2.7L 20V ELETRÔNICO(EURO3)



5617002

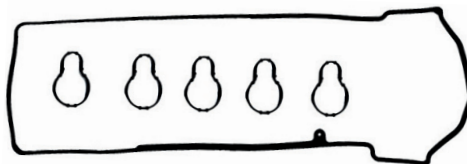

56176140

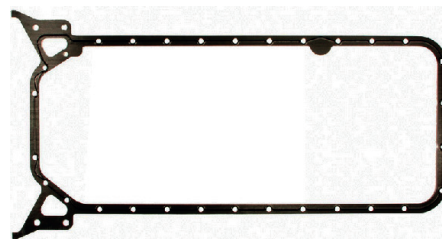

56176430

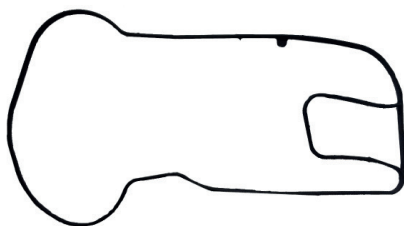

56177140

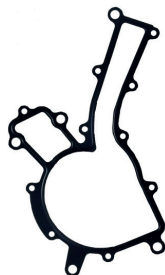

56176630



56176730



56176330



56176230



56176540



56176830



56177040



RE005813S



RE07795T



RE07927F



86152640

Nº JOGO		DESCRIÇÃO		
76112702		JOGO DE JUNAS COMPLETO DO MOTOR MERCEDES OM651 CDI COM RETENTORES	1	
76132702		JOGO DE JUNTAS SUPERIOR DO MOTOR MERCEDES OM651 CDI COM RETENTORES	2	
Nº ABR	Nº ORIGINAL	DESCRIÇÃO		
56177302	6510160220	JUNTA DO CABEÇOTE	1	1
56177240	6510160021	JUNTA DA TAMPA DAS VÁLVULAS (ATÉ 2011)	1	1
56180940	6510160321	JUNTA DA TAMPA DAS VÁLVULAS 2012/...	1	1
56177432	6511420580	JUNTA DO COLETOR DE ESCAPAMENTO	1	1
56177640	6510910060	JUNTA DO COLETOR DE ADMISSÃO	1	1
56177540	6510140080	JUNTA DO CÂRTER		1
RE09116F	96*114*9	RETENTOR TRASEIRO DO VIRABREQUIM		1
RE09115F	69*75*7.5/8.5	RETENTOR DIANTEIRO DO VIRABREQUIM		1
RE09203F	5*8.5*9.5	RETENTOR DA HASTE DAS VÁLVULAS	16	16
56177730		JUNTA DO TUBO DE ESCAPE	1	1
56177830	6510961180	JUNTA DA TAMPA TRASEIRA DO CABECOTE	1	1
56177918	651422680	JUNTA DA VÁLVULA EGR	1	1
56178030	6510960480	JUNTA DO TURBO	1	1
56178130	6511420380	JUNTA DA VÁLVULA EGR	1	1
56178230	6511420480	JUNTA DA VÁLVULA EGR	1	1
56178330	6511421280	JUNTA DA VÁLVULA EGR	1	1
56178430	6511421380	JUNTA DA VÁLVULA EGR	1	1
56178530	6511422380	JUNTA DA VÁLVULA EGR	1	1
56178630	6510960280	JUNTA DO RETORNO ÓLEO	1	1
56181330	5612380180	JUNTA DA BOMBA DE ÓLEO	1	1
56181430	5611422480	JUNTA DO TROCADOR DE CALOR	1	1
86152740		KIT DE BORRACHAS		1
86152840		KIT DE BORRACHAS DO JOGO SUPERIOR	1	

• VENDE-SE AVULSO

APLICAÇÃO



MERCEDES OM 651 A CILINDROS 2.2L 16V ELETRÔNICO (EURO 5)

MERCEDES VANS SPRINTER 311/415/515 CDI 2012/...

MERCEDES OM651 4 CILINDROS 2.1L 16V CDI ELETRÔNICO(EURO5) 2012

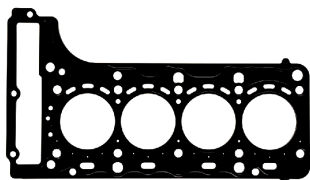

56177302

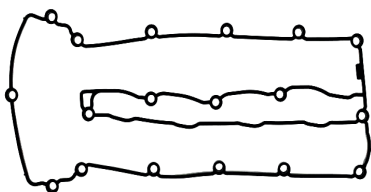

56177240

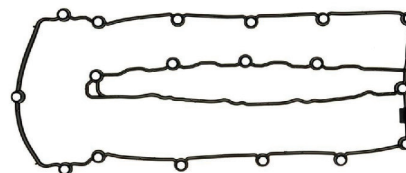

56180940

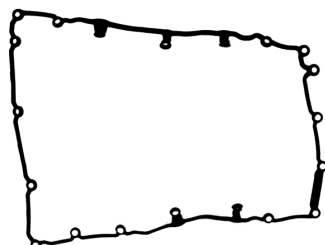

56177540



56177432



561781330



56177640



56181430



56177830



56178130



56178230



56177918



56178030



56178630



56178430



56178530



56178330



56177730



RE09116F



RE09115F



RE09203F

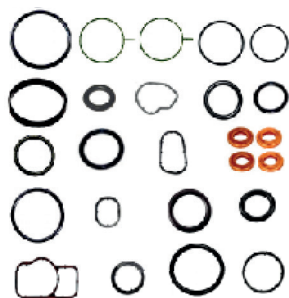

86152740

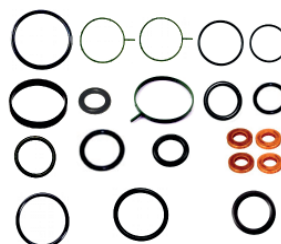

86152840

Nº JOGO	DESCRIÇÃO
76114735	JOGO DE JUNTAS COMPLETO MERCEDES OM 501(MOTOR 012091 ATÉ 084423)COM RETENTORES SEM ANEL DE CAMISA 1
76114745	JOGO DE JUNTAS COMPLETO MERCEDES OM 501(MOTOR 084424 ATÉ 155295)COM RETENTORES SEM ANEL DE CAMISA 2
76114715	JOGO DE JUNTAS COMPLETO MERCEDES OM 501(MOTOR 155296 ATÉ 377748)COM RETENTORES SEM ANEL DE CAMISA 3
76114725	JOGO DE JUNTAS COMPLETO MERCEDES OM 501(APÓS MOTOR 377749)COM RETENTORES SEM ANEL DE CAMISA 4
76134735	JOGO DE JUNTAS SUPERIOR MERCEDES OM 501/502(MOTOR 012091 ATÉ 084423)COM RETENTORES 5
76134745	JOGO DE JUNTAS SUPERIOR MERCEDES OM 501/502(MOTOR 084424 ATÉ 155295)COM RETENTORES 6
76134715	JOGO DE JUNTAS SUPERIOR MERCEDES OM 501/502(MOTOR 155296 ATÉ 377748)COM RETENTORES 7
76134725	JOGO DE JUNTAS SUPERIOR MERCEDES OM 501/502(APÓS MOTOR 377749)COM RETENTORES 8
76134730	JOGO DE JUNTAS INFERIOR MERCEDES OM 501(TODOS)COM RETENTORES SEM JUNTA DE CÁRTER 9
76134720	JOGO DE JUNTAS INFERIOR MERCEDES OM 501(ATÉ MOTOR 012090)COM RETENTORES COM JUNTA DE CÁRTER SOFT 10
76134710	JOGO DE JUNTAS INFERIOR MERCEDES OM 501(APÓS MOTOR 012091)COM RETETENORES COM JUNTA CÁRTER BORRACHA 11

Nº ABR	Nº ORIGINAL	DESCRIÇÃO								
56179205	5410161120	JUNTA DO CABEÇOTE OM501/502 (ATÉ MOTOR 377748)			1	1	1	6	6	6
56179305	5410161320	JUNTA DO CABEÇOTE OM501/502 (APÓS MOTOR 377749)		1			6			
56165940	4570160121	JUNTA DA TAMPA VÁLVULA OM501/502(APÓS MOTOR 155296)OM		1	1		6	6		
56181040	5410160321	JUNTA DA TAMPA VÁLVULA OM501/502(ATÉ MOTOR 084423)				1				6
56179440	5410160421	JUNTA DA TAMPA VÁLVULA OM501/502(MOTOR 084424 ATÉ 155295)				1			6	
54168030	5411420280	JUNTA DO COLETOR ESCAPE OM 501/502/457		1	1	1	1	6	6	6
56179730	5410980480	JUNTA DO COLETOR ADMISSÃO OM 501/502		1	1	1	1	6	6	6
56179540	5410140722	JUNTA DO CÁRTER DE BORRACHA OM502(APÓS MOTOR 012091)	1					1	1	1
56179867	5410140322	JUNTA DO CÁRTER SOFT OM502(ATÉ MOTOR 012090)		1						
56180430	5410151180	JUNTA DA TAMPA FRONTAL - ESQUERDA	1	1	1			1	1	1
56180530	5410151280	JUNTA DA TAMPA FRONTAL - DIREITA	1	1	1			1	1	1
56180340	5410151380	JUNTA DA TAMPA DISTRIBUIÇÃO	1	1	1			1	1	1
56180740	5410150160	JUNTA DA TAMPA DISTRIBUIÇÃO	1	1	1			1	1	1
RE02697T	139971447	RETENTOR TRASEIRO DO VIRABREQUIM MBB OM457/501/502	1	1	1			1	1	1
RE02696T	149974647	RETENTOR DIANTEIRO DO VIRABREQUIM MBB OM457/501/502	1	1	1			1	1	1
RE09237F	533558	RETENTOR DA HASTE DAS VÁLVULAS OM457/501/502				4	4	4	4	24
56132267	5410110080	JUNTA DA TAMPA TRASEIRA	1	1	1			1	1	1
56141030	5411310780	JUNTA DO COMPRESSOR	2	2	2			2	2	2
56169300	9425010080	JUNTA DO TUBO DA ENTRADA DA BOMBA DE ÁGUA	1	1	1			1	1	1
56180130	5422010180	JUNTA DA BOMBA DE ÁGUA	1	1	1			1	1	1
56180230	5411840980	JUNTA DO RESFRIADOR DO ÓLEO	1	1	1			1	1	1
56180630	5422010180	JUNTA DA CONEXAO DA BOMBA DE ÁGUA	1	1	1			1	1	1
56181132	5410110459	CALÇO DE CAMISA 0,15MM	6	6	6			6	6	6
86153140		KIT DE BORRACHAS E ARRUELAS	1	1	1			1	1	1

• VENDE-SE AVULSO

APLICAÇÃO



MERCEDES CAMINHÃO ACTROS 2646S 2010/... 2546S 2011/... 4844K 2008/17 4144K 2008/...

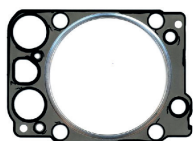

56179205

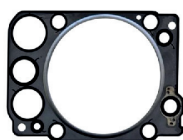

56179305



56179540

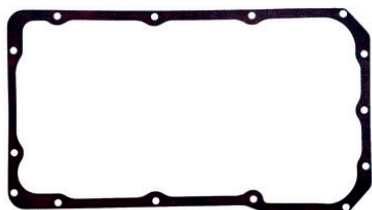

56179867



56180740



56180340

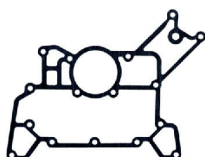

56180230

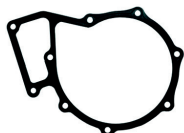

56177040



56180430



56180530



56132298



56181040



56179440



56165940



56141030



56179730



56180630



56169300



56168030



RE02697T



RE02696T



56181132



RE09237F



86153140

Nº JOGO	DESCRIÇÃO
76114755	JOGO DE JUNTAS COMPLETO MERCEDES OM 502(MOTOR 012091 ATÉ 084423)COM RETENTORES SEM ANEL DE CAMISA 1
76114765	JOGO DE JUNTAS COMPLETO MERCEDES OM 502(MOTOR 084424 ATÉ 155295)COM RETENTORES SEM ANEL DE CAMISA 2
76114775	JOGO DE JUNTAS COMPLETO MERCEDES OM 502(MOTOR 155296 ATÉ 377748)COM RETENTORES SEM ANEL DE CAMISA 3
76114785	JOGO DE JUNTAS COMPLETO MERCEDES OM 502(APÓS MOTOR 377749)COM RETENTORES SEM ANEL DE CAMISA 4
76134735	JOGO DE JUNTAS SUPERIOR MERCEDES OM 501/502(MOTOR 012091 ATÉ 084423)COM RETENTORES 5
76134745	JOGO DE JUNTAS SUPERIOR MERCEDES OM 501/502(MOTOR 084424 ATÉ 155295)COM RETENTORES 6
76134715	JOGO DE JUNTAS SUPERIOR MERCEDES OM 501/502(MOTOR 155296 ATÉ 377748)COM RETENTORES 7
76134725	JOGO DE JUNTAS SUPERIOR MERCEDES OM 501/502(APÓS MOTOR 377749)COM RETENTORES 8
76134760	JOGO DE JUNTAS INFERIOR MERCEDES OM 502(TODOS)COM RETENTORES SEM JUNTA DE CÂRTER 9
76134750	JOGO DE JUNTAS INFERIOR MERCEDES OM 502(ATÉ MOTOR 012090)COM RETENTORES COM JUNTA DE CÂRTER SOFT 10
76134740	JOGO DE JUNTAS INFERIOR MERCEDES OM 502(APÓS MOTOR 012091)COM RETENTORES COM JUNTA CÂRTER BORRACHA 11

Nº ABR	Nº ORIGINAL	DESCRIÇÃO											
56179205	5410161120	JUNTA DO CABEÇOTE OM501/502 (ATÉ MOTOR 377748)				1	1	1		8	8	8	
56179305	5410161320	JUNTA DO CABEÇOTE OM501/502 (APÓS MOTOR 377749)			1				8				
56165940	4570160121	JUNTA DA TAMPA DE VÁLVULA OM501/502(APÓS MOTOR 155296)OM		1	1				8	8			
56181040	5410160321	JUNTA DA TAMPA DE VÁLVULA OM501/502(ATÉ MOTOR 084423)						1					8
56179440	5410160421	JUNTA DA TAMPA VÁLVULA OM501/502(MOTOR 084424 ATÉ 155295)						1					8
54168030	5411420280	JUNTA DO COLETOR ESCAPE OM 501/502/457		1	1	1	1	1	8	8	8	8	
56179730	5410980480	JUNTA DO COLETOR ADMISSÃO OM 501/502		1	1	1	1	1	8	8	8	8	
56179967	5410140722	JUNTA DO CÂRTER OM502(ATÉ MOTOR 012090)SOFT		1									
56179640	5410140322	JUNTA DO CÂRTER OM502(APÓS MOTOR 012091)BORRACHA	1							1	1	1	1
56180430	5410151180	JUNTA DA TAMPA FRONTAL - ESQUERDA	1	1	1					1	1	1	1
56180530	5410151280	JUNTA DA TAMPA FRONTAL - DIREITA	1	1	1					1	1	1	1
56180340	5410151380	JUNTA DA TAMPA DE DISTRIBUIÇÃO	1	1	1					1	1	1	1
56180740	5410150160	JUNTA DA TAMPA DE DISTRIBUIÇÃO	1	1	1					1	1	1	1
RE02697T	139971447	RETENTOR TRASEIRO DO VIRABREQUIM MBB OM457/501/502	1	1	1					1	1	1	1
RE02696T	149974647	RETENTOR DIANTEIRO DO VIRABREQUIM MBB OM457/501/502	1	1	1					1	1	1	1
RE09237F	533558	RETENTOR DA HASTE DAS VÁLVULAS OM457/501/502				4	4	4	4	32	32	32	32
56132267	5410110080	JUNTA DA TAMPA TRASEIRA	1	1	1					1	1	1	1
56141030	5411310780	JUNTA DO COMPRESSOR	2	2	2					2	2	2	2
56169300	9425010080	JUNTA DO TUBO DA ENTRADA DA BOMBA DE ÁGUA	1	1	1					1	1	1	1
56180130	5422010180	JUNTA DA BOMBA DE ÁGUA	1	1	1					1	1	1	1
56180230	5411840980	JUNTA DO RESFRIADOR DO ÓLEO	1	1	1					1	1	1	1
56180630	5422010180	JUNTA DA CONEXÃO DA BOMBA DE ÁGUA	1	1	1					1	1	1	1
56181132	5410110459	CALÇO DE CAMISA 0,15MM	8	8	8					8	8	8	8
86153140		KIT DE BORRACHAS E ARRUELAS	1	1	1					1	1	1	1

• VENDE-SE AVULSO

APLICAÇÃO



MERCEDES CAMINHÃO ACTROS 2655 LS 2013/16

MERCEDES OM 502LA 8 CILINDROS 16L 32V V8 EURO 5

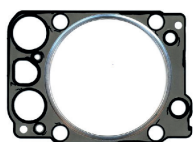

56179205

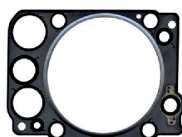

56179305



56179640

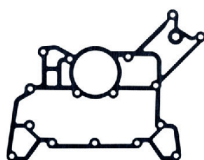

56180230

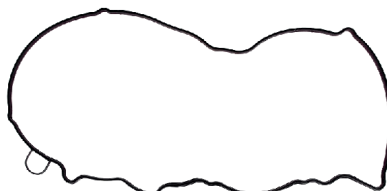

56180740



56180340



56132298

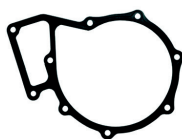

56180130



56180430



56180530



56141030



56181040



56179440



56165940



56181132



56179730



56180630



56169300



56168030



RE02697T



RE02696T



RE09237F



86153140